



AGENDA
COMMUNITY DEVELOPMENT COMMITTEE
Monday, June 13, 2016

5:30 PM

**Public Safety Building
285 North Seven Hills Road**

I) Roll Call

II) Approval of Minutes – May 9, 2016

III) Items Requiring Council Action – Monday, June 20, 2016

- A. Fezziwig's Redevelopment Agreement (1st Reading)
- B. Milburn Estates 1st Addition – Final Plat (1st Reading)
- C. Parkview Meadows – Phase 1 – Final Plat (1st Reading)
- D. Lincoln Park Villas – Planned Use (1st Reading)
- E. Text Amendment – Permitted Structures in the SR-3 Zone District (1st Reading)

IV) Other Business – None

NEXT MEETING: June 27, 2016 – 6:00 P.M. – Public Safety Building

General Citizen Comments: The City of O'Fallon welcomes comments from our citizens. The Illinois Open Meetings Act provides an opportunity for citizens to speak at all committee and Board meetings. However, 5 ILCS 120/1 mandates that NO action shall be taken on matters not listed on the agenda. Please submit your name to the chairman and limit your comments so that anyone present has the opportunity to speak.



MINUTES
COMMUNITY DEVELOPMENT COMMITTEE
6:00 PM Monday, May 9, 2016

Minutes of a regular meeting of the Community Development Committee of the City of O'Fallon, held at the Public Safety Building, 285 N. Seven Hills Road, O'Fallon, Illinois.

CALL TO ORDER: 6:25 PM

- I) **Roll Call** – *Committee members:* Jerry Albrecht, Gene McCoskey, David Cozad, Harlan Gerrish and Ray Holden. *Other Elected Officials Present:* Mike Bennett, Matt Smallhear, Rich Meile, Kevin Hagerty, Herb Roach, Robert Kueker and Ned Drolet. *Staff:* Walter Denton, Pam Funk, James Cavins, Grant Litteken, Ted Shekell and Justin Randall. *Visitors:* Ron Zelms, Rick Reckamp, Craig Hubbard, Mark Hodapp and Charlie Pitts.
- II) **Approval of Minutes from Previous Meeting** – All ayes. Motion carried.
- III) **Items Requiring Council Action**
 - A. SEPA – Pre-Street Machine Nationals Cruise-In (Motion) – Justin Randall provided a brief overview of the special event permit for Gateway Classic Cars on June 22nd. The committee discussed the special event permit and recommended approval of the special event with a vote of 5-0, with the recommended staff conditions.
 - B. SEPA – Kloss Furniture Tent Sale (Motion) – Justin Randall provided a brief overview of the special event permit for Kloss Furniture from June 8th to June 21st. The committee discussed the special event permit and recommended approval of the special event with a vote of 5-0, with the recommended staff conditions.
 - C. Chapter 116 – Alcoholic Beverage Text Amendments (2nd Reading) – Justin Randall indicated there were no changes from 1st Reading.
 - D. Courage and Grace – Planned Use (2nd Reading) – Justin Randall indicated there were no changes from 1st Reading.
 - E. Savannah Hills – 3rd Addition – Final Plat (2nd Reading) – Justin Randall indicated there were no changes from 1st Reading.
- IV) **Other Business** – None

MEETING ADJOURNED: 6:30 PM

NEXT MEETING: May 9 2016 – Public Safety Building

Prepared by: Justin Randall, Senior City Planner

DRAFT MINUTES
O’FALLON PLANNING COMMISSION
May 24, 2016

Chairman Jeff Baskett called the meeting to order at 6:01 p.m. in the City Council Chambers and led the Pledge of Allegiance.

ATTENDANCE: Debbie Arell-Martinez, present; Jeffrey Baskett, present; Patricia Cavins, present; Al Keeler, excused; Rebecca Pickett, present; Joe Rogers, present; Ray Rohr, present; Larry Sewell, excused. A quorum was declared present by Baskett.

MINUTES: Motion was made by Pickett and seconded by Arell-Martinez to approve the minutes of April 12, 2016 meeting. All Ayes. Motion carried.

Baskett welcomed everyone and explained the role of the Planning Commission. The Planning Commission members introduced themselves. Also present were Community Development Director Ted Shekell and Senior City Planner Justin Randall. Present in the audience was City Alderman Ray Holden, City Alderman Ned Drolet, City Alderman Kevin Hagarty, O’Fallon Library Board member Linda Gruchala, O’Fallon Library Director Molly Scanlan, Woodgate Subdivision residents Lois Ridenour, Bill Chapman, Susan Edelman, and Mary Drolet, petitioner Chad Hartle of RCH Development, Inc., and O’Fallon Police Captain Jim Cavins. Baskett gave an overview of the process that would be followed for the evening.

UNFINISHED BUSINESS: None.

PUBLIC HEARINGS:

(P2016-03) –Zoning Amendment Subject to the Planned Development Ordinance from “B-1” Community Business District to “MR-2(P)” Planed Multi-Family Residence Dwelling District for “Lincoln Park Villas,” a 72-unit multi-family senior citizen community. Property is located at 1159 South Lincoln Ave., south of GCS Credit Union and the O’Fallon Public Library. The applicant is Chad artle, for RCH Development Inc.

Public hearing was opened at 6:03 pm. Randall presented an overview of the project and staff report. Maps of the subject and surrounding properties, and their zoning were shown. Randall highlighted various points and issues from Staff’s Project Report, among them:

The development is a 72 unit senior living community. There will be 18 one-bedroom units and 54 two-bedroom units. This comes to approximately 11.3 units per acre and falls within the limits of 16 units per acre maximum allowed. The project will extend the access to Civic Plaza. It currently ends at the Public Library and GCS Credit Union. The road will connect the Library and GCS Credit Union, will be 32 feet wide, and have a 60 foot right of way. There are currently water and sewer lines stubbed out, the proposed development will extend utilities. There will be four points of access to Civic Plaza. The proposed parking lot will contain 162 spaces, which is greater than the required 144

minimum parking spaces. The parking stalls will be 10 ft. x 19 ft., which meets code requirements, and drive aisles will be 24 feet wide. Sidewalks will be placed throughout along South Lincoln Ave. and Civic Plaza to provide pedestrian access.

A detention pond is proposed for the northwest corner of the subject property. There is also an existing detention basin in the southeast corner that will be utilized as well. This existing detention basin was sized to accommodate future development. The developer will provide landscaping as required by the code. This development requires 0.72 acres of Park Land dedication. In lieu of land, the development will be assessed a Park Land dedication fee of \$510 per unit. This fee is based on occupant load.

Elevations were presented by Randall. The structure will include stone, brick, and Hardie Board. Randall indicated the design and materials are consistent with residential development throughout the city. Staff believes this development will not cause any adverse impact on neighboring property.

Rohr asked about age restrictions for the proposed community. Randall stated there will be a 55+ age restriction. Rohr asked if, and how, the residences will be subsidized, such as Section 8 Housing. Randall referred to the developer for further clarification, and stated the developer has obtained IDHP financing.

Baskett stated the age restriction is recorded on the deed to the property. He inquired that if the restriction needed to be removed would it need to go through the city. Shekell stated yes, and the financing of the development is tied to the age restriction. Shekell also stated this development must stay in single ownership to ensure consistent management. There will be a deed restriction for single ownership as well.

Public comments were opened at 6:12 pm.

Petitioner Chad Hartle was sworn in. Hartle introduced himself as the developer. He stated the 54 two-bedroom units will be 865 sq. ft., and rent for \$670 per month. Hartle stated the average two-bedroom unit in O'Fallon rents for \$936. The 18 one-bedroom units will be 750 sq. ft. and rent for \$573 per month. Hartle stated the average one-bedroom unit in O'Fallon rents for \$840 per month. Hartle listed the facility amenities, including a club house with fitness equipment, a gathering room, full-time onsite property management, and a spare office to conduct events such as wellness screenings, tax preparation, and educational opportunities.

Hartle further stated he has been developing senior housing for 26 years. Hartle has created 25 developments, the majority of which are senior housing, and has never sold a development. The proposed development will have recorded deed restrictions through the Illinois Housing Development Commission requiring Hartle to rent to seniors age 55 and above.

Hartle intends to work closely with the O'Fallon Public Library, especially for the adult education program. Completing Civic Drive will also benefit the Library. Hartle has been working with the Library to develop signage that will incorporate both the development

and the Library. He further stated the proximity to the post office, banks, grocery stores, hospital, and other surrounding services make the proposed site desirable.

Hartle stated the proposed development will use Universal Design, including wide hallways and other safety measures as well as using energy efficient building practices, such as geothermal energy and heat pumps if the budget allows. The units will be rated and certified by the National Association of Home Builders as well as by the International Code Council. Hartle referenced a development he owns in Troy, Missouri, stating it is illuminated with 100% LED lights.

Hartle stated the current zoning of the subject property would allow for his development, however staff recommended rezoning to protect nearby residents to the east and west from any future business use. Hartle explained he will continue to own this development and there will be an investor who purchases the tax credits.

Hartle reiterated the intent of the development is to provide a place for seniors to live independently for many years. He stated the typical resident is a widow or widower that cannot, or does not want to, care for their home any longer. Hartle cited the average utility bills for his current developments as \$38 per month for a one-bedroom unit and \$58 per month for a two-bedroom unit. Hartle compared these averages to the average rate of \$100 - \$150 per month for traditional apartments. The proposed development units will be all electric, the resident will pay electric bill. At this time Hartle was unsure who will be responsible for the water bill.

Rohr asked for locations of Hartle's previous developments and Hartle provided various locations.

Rohr asked Hartle if the proposed development is the first he has completed in Illinois. Hartle stated he completed an affordable housing development in the early 1990's. He further stated it was a rural development program. Hartle explained at that time the program was administered by the Federal Government, however it has since shifted to the state level.

Rohr inquired about the rent discounts available due to the funding. Hartle stated the process to receive tax credits for these types of developments is very competitive. This year the State of Illinois awarded tax credits to 11 out of approximately 50 applicants, with the proposed development being the furthest south in the state to receive approval.

Hartle explained the neighbor notification process required for Planned Use developments, stating he sent the required notices along with an additional introductory notice describing the nature of the proposed development and providing his personal cell phone number.

Hartle emphasized his pride in his existing developments, describing improvements he has made to his early developments using tax credits to make those units more energy efficient and accessible.

Rohr asked how the developer plans to keep non-senior family members from moving in to the development. Hartle described the occupancy standards and stated any occupants must have a familial relationship. Hartle further stated this is not an issue in any of his other developments. The rules, regulations, and management is strict; disturbances are grounds for lease termination and eviction.

Rohr stated the rent rates are very attractive and is concerned families will move in due to the rate and the development will not remain a senior community.

Baskett asked if Hartle has seen similar rate spreads between senior developments versus traditional apartment housing in other markets.

Hartle stated the gap is actually larger in Missouri because there is an additional state housing tax credit. He stated the average rate of his one-bedroom unit in Missouri is \$390 per month and is nearly half the traditional apartment rate.

Baskett asked if Hartle experiences the afore mentioned concerns in the Missouri developments. Hartle stated he does not. Hartle further explained their occupancy standards require that a visitor can stay for no more than 14 days. If anyone moves in that is not on the lease, or has a visitor for more than 14 days, it is grounds for eviction. There are safeguards built in to protect the development and residents while abiding by the law. Hartle reiterated the aforementioned concerns have not been an issue and invited anyone to visit their existing developments.

Hartle stated the typical resident has one car or less, and does not believe all the required parking spaces will be utilized. Hartle went on to discuss the Walk Score rating, stating that typical communities south of Chicago have a Walk Score of 30 – 35. Lincoln Avenue in O'Fallon has a walk score of 84.

Susan Edlmann, a resident of Woodgate, was sworn in. Edlmann stated the businesses surrounding this development are near a very busy intersection, which may pose a danger to the residents of this development. Edlmann also stated she believes the area of the proposed development is a "growth corridor" and this development is not the best use of the land. Edlmann recommended medical office use and expressed concerns about low income housing deteriorating the city.

Bill Chapman, resident and board member of Woodgate, was sworn in. Chapman asked if the development will be Section 8 Housing. Hartle stated it will not be, and it cannot be, Section 8. Chapman expressed concerns about rent rates being too low and families with teenagers moving in to the development. Chapman asked how close the proposed building will be to the property line. Hartle requested the site plan be displayed again. Baskett stated the drawing shows a 10 foot setback. Shekell stated there is a 10 foot easement and the proposed building is right next to the easement. Shekell stated the city would like to see more room because the concrete patio pads will actually be located in the utility easement. If the city needed to access the easement the patios may need to be excavated. Hartle stated he would work to see if more room could be made. Shekell stated the typical rear setback is 25 feet. While this area is technically considered a side yard, for practical purposes, this area is the back.

Hartle stated they have been working very hard to address the drainage on the west side of the site. The front third drains forward on to Lincoln Ave., the back two-thirds drains to the south-west corner, however the majority drains to the detention basin. Shekell stated they would further discuss the setback, saying 25 feet would be best, 20 feet would be acceptable. Hartle stated he would like relief on the setback from Civic Plaza. This relief would allow him to adjust the rear setback.

Chapman asked for details regarding where the detention pond drains. Shekell provided details. Chapman stated the Woodgate neighborhood's main concern is drainage. Shekell stated that if water runoff is coming from the subject property, the development of the site will alleviate the problem. Shekell cited the development of Rasp Farms. Previously water ran off from Interstate 64, on to the vacant farmland, and into adjoining properties. The proposed development will be obligated by city and state law to address drainage problems on the subject property, which should help Woodgate.

Chapman again stated concern about the property line setback. Shekell said the city would like to see at least 20 feet.

Chapman asked if the trees along the fence line would be removed. Hartle stated he must remove them in order to alleviate the drainage. Shekell asked if Hartle will be adding a ditch. Hartle stated plan A is to create a swale and direct toward the detention pond. Plan B is an open concrete trough. Plan C is to create a swale in the parking lot or possibly a bio-detention area.

Shekell asked about plan for roof drains. Hartle explained the impact of adding impervious surfaces to a previously vacant land and basic principles for remediating it. Chapman mentioned drainage issues in Woodgate caused by traditional downspouts. Hartle suggested a joint venture between both Woodgate and himself to reshape the land to improve drainage for both parties. Chapman invited Hartle to visit Woodgate.

Hartle restated the low rent concern, stating that if he could reduce his rent \$100 or \$200 he would, because he knows it works and his tenants appreciate it.

Chapman stated the area's cost of living has gone down and he has seen vandalism along the fence line. Hartle invited Chapman and Woodgate to visit any of his other developments. Hartle described the tenant screening process, including background checks and landlord references.

Shekell mentioned the Crime Free Rental Housing Program and how the City helps to keep multifamily housing clean, safe, and sustainable.

Hartle described several developments he owns in Cape Girardeau. Hartle stated Cape Girardeau was experiencing some issues with rental housing and the mayor at the time asked Hartle to put on a landlord seminar which had 200 people in attendance. Hartle listed several mayors in Cape Girardeau and surrounding communities that could serve as references for the quality of his property management.

Baskett thanked Hartle for the information and asked that the focus of the discussion remain on the project at hand.

Chapman asked if there will be a privacy fence on the development along the side adjacent to the library. Hartle stated he believed there will be a berm. Randall confirmed there is a fence on the plans. Shekell mentioned concerns about headlights shining in the units.

Shekell introduced Molly Scanlan, O'Fallon Public Library Director. Shekell discussed the possibility of joint signage for the library and the proposed development. Scanlan stated that there is only one access point in and out of the library, and it is becoming increasingly dangerous. Scanlan said the Library needs a second access point. Shekell said the second entrance and exit point will be helpful as will the additional signage. Scanlan stated there is a need for a crosswalk as well.

Kevin Hagarty, Ward 3 Alderman, was sworn in. Hagarty asked Shekell and Randall to describe the future plans for Lincoln Ave. due to the increased traffic and upcoming developments. Shekell stated there will be a turn lane at Garden Salon and Rasp Farm. There will also be a traffic signal on Lincoln to serve Rasp Farm and the dental clinic on the west side of Lincoln. This will provide periodic breaks which should make it easier for pedestrians and vehicles crossing Lincoln. Shekell agreed a crosswalk should be looked in to.

Edelmann asked if the development was placed far enough back so that Lincoln Ave. could be widened in the future. Baskett stated the development is set back 50 feet.

Chapman asked for clarification on the entrance. Shekell described where it would be.

Baskett asked if this development required a traffic study. Shekell stated it was not necessary for this development. If this project were a business development it would likely have higher traffic volume.

Ned Drolet, Ward 6 Alderman, was sworn in. Drolet described various projects that had been proposed for the subject property in the past and stated he did not believe the proposed project was the best use of the property. Drolet stated he was also extremely concerned with drainage, and expressed hope that the proposed development will relieve some of the current problems.

Molly Scanlan, O'Fallon Public Library Director, was sworn in. Scanlan expressed support for the project. Scanlan stated that rental communities are more about the management quality than the price.

Public comments were closed at 7:07 pm.

Staff Recommendation:

Randall read over the Staff Recommendation as follows:

Staff recommends approval of the project with the following conditions. A park land dedication fee of \$510.00 per unit, totaling \$36,720.00, is required in lieu of land, a revised landscaping plan is required to include street trees and fencing, and the final plat must have deed restrictions that limit the age to 55 years and older as well as restrictions prohibiting the sale of individual buildings or lots.

Baskett stated that the Planning Commission should also take in to account the change to the side setback when making their recommendation to City Council. Baskett asked Shekell for a recommended measurement. Shekell stated 20 feet minimum for utilities and drainage. Randall mentioned that some allowances may need to be made along Civic Plaza if the minimum side setback requirement is changed. Shekell stated it will be worked out with the engineer.

Motion was made by Rogers to approve the Staff Recommendation with amendment to 20 foot setback and seconded by Pickett.

ROLL CALL: Arell-Martinez, aye; Cavins, aye; Pickett, aye; Rogers, aye; Rohr, nay; Baskett, aye. Motion to approve with amendment to setback and Staff's conditions passed.

The project moves to Community Development on June 13, 2016 at 6 pm. The public hearing was closed at 7:11 pm.

(P2016-04) – Text amendment to Title XV Land Use, Chapter 158 – Zoning Code of Ordinances regarding permitted principal structures in the SR-3, Single-Family Residence Dwelling District.

Public Hearing was opened at 7:12 pm. Randall described the principal structures currently permitted under SR-3 zoning classification and the general locations of SR-3 zoning within the City. There are four basic building types including conventional stick built, prefabricated, modular with permanent foundations, and manufactured homes. Both modular and manufactured require approval from the State of Illinois. SR-3 allows for stick built, prefabricated, and modular homes. Randall stated this has not been an issue in the past, and often modular homes look just like stick built homes.

Randall presented a recent modular home placed in the downtown area that has a side entry and does not match the general character of the surrounding homes. The structure was permitted under the current SR-3 zoning and the City had no recourse to deny the permit. Staff worked with property owner for weeks to persuade them to choose a different style home or construction, but was not successful. Randall said rather than make exceptions it was simpler to prohibit them.

Shekell agreed that it is easier to prohibit, and Staff received many complaints on the aforementioned building. He described modular homes, stating they are delivered in two pieces and have a seal on the electrical box from the Illinois Department of Public Health. They are similar to manufactured homes in this respect. Shekell stated the

aforementioned home was not inexpensive, it is just out of character with all other adjacent homes.

Pickett asked if there is any reference in the code to dictate the orientation of the home.

Shekell discussed the various inconsistencies of this home compared with the neighboring properties, citing the side entrance and low roof pitch. Shekell went on to describe the potential problems that could arise if this style of home continues to be permitted in the SR-3 district. Modular homes will continue to be permitted in the Mobile Home Districts as well as the Multi-Family Districts.

Rohr inquired about home orientation, asking if a traditional stick built home could be oriented this same way as the subject modular home. Rohr stated prohibiting modular homes is irrelevant if stick built homes can be built the same way. Shekell cited a previous situation that was similar with stick built homes. A moratorium had been placed to prevent those homes from being built, however the moratorium has expired.

Randall stated the subject property only became a problem due to the size of the lot. If the home were stick built, it would have been a typical shotgun style home, but due to this home being modular, it could not fit any other way.

Cavins asked for clarification as to where the front door faces. Randall showed the location and stated the front door of the subject home faces a home that is occupied by a familial relation.

Staff Recommendation:

Randall read over the Staff Recommendation as follows:

Staff recommends adopting the text amendment to prohibit a modular building structure in the SR-3 zone district.

Shekell stated Pickett has a good point regarding the home orientation.

Rohr asked how someone could propose a development with modular homes in the future. Shekell stated they would need to rezone the property for mobile homes. Shekell went on to describe the construction of modular homes. Randall cited Southview Gardens is a subdivision of all prefabricated homes.

Motion was made by Pickett and seconded by Arell-Martinez to approve the Staff's Recommendation as written.

ROLL CALL: Arell-Martinez, aye; Cavins, aye; Pickett, aye; Rogers, aye; Rohr, aye; Baskett, aye. All Ayes. Motion to approve passed.

This text amendment moves to Community Development on June 13th, 2016 at 6:00 pm.

The public hearing was closed at 7:27 pm.

REPORTS OF STANDING AND SPECIAL COMMITTEES: None.

REPORTS AND COMMUNICATION:

Randall announced that there the next meeting is scheduled for June 14, 2016. There should be a public hearing for First United Methodist Church to expand their parking lot and an annexation for a Boat and RV storage facility on East Highway 50.

Shekell mentioned TownePlace Suites will begin this summer behind Bella Milano. The Developer is Brad McMillin.

Randall stated McMillin has entered in to a contract with the City for Old City Hall.

ADJOURNMENT:

Motion was made by Rohr and seconded by Arell-Martinez to adjourn. All ayes. Motion carried. The meeting was adjourned at 7:34 pm.

Respectfully submitted,

Jessica Short, Transcriptionist

Minutes approved by Planning Commission



MEMORANDUM

TO: Community Development Committee
FROM: Ted Shekell, Director of Community Development
DATE: June 13, 2016
SUBJECT: Redevelopment Agreement for Fezziwig's/Metro Inflatables, LLC

Summary: Attached is the proposed TIF redevelopment agreement for 225 West First Street. The property is owned by Greg Muren of Metro Inflatables, LLC and the tenant is Fezziwig's Marketplace. Fezziwig's was looking for new locations for their business while the City of O'Fallon was in the process of creating the new Central City TIF district. At the time, they inquired about receiving financial assistance from the TIF district and they were told their project would be eligible, pending the creation of the TIF district and City Council approval of their agreement. As this is the first TIF redevelopment agreement in the Central City TIF district, it took some time for both parties to get the agreement in place. It provides for 75% of increment generated by the property to be returned to the property owner. The property owner must then provide proof that Fezziwig's is reimbursed for the percentage of the improvements they paid for.

REDEVELOPMENT AGREEMENT

This Redevelopment Agreement (including the Exhibits) (“Agreement”) is entered into on the date and by execution shown hereafter, by and between the **City of O’Fallon**, Illinois, an Illinois Municipal Corporation, (hereinafter referred to as “City”) and **Metro Inflatables, LLC**, an Illinois corporation doing business under the assumed name Metro Inflatables, LLC (hereinafter collectively referred to as “the Developer”).

PREAMBLE

WHEREAS, the municipality has the authority to promote health safety and welfare, including to prevent the spread of blight and deterioration and inadequate public facilities by promoting the development of and private investment in industry, business and housing and enhancing the marketability of real property, thereby increasing the tax base of the municipality and reducing unemployment; and

WHEREAS, the Developer owns the following described real estate located in the City of O’Fallon, St. Clair County (the “Property”) on which is situated a certain building:

Parcels consisting of parts of Lot 10 and Lot 11 of O’Fallon Original Town, City of O’Fallon, St. Clair County, Illinois, described as follows:

Permanent Parcel Nos. 04-30.0-403-005, 04-30.0-403-006, and 04-30.0-403-007;

WHEREAS, the City desires to encourage the Developer to renovate the existing building for a retail business in the City of O’Fallon (which renovation is hereinafter referred to as the “Project”); and

WHEREAS, pursuant to the Tax Increment Allocation Redevelopment Act, 65 ILCS 5/11-74.4 et seq., as amended (the “TIF Act”), the City has the authority to provide incentives to owners or prospective owners of real property to redevelop, rehabilitate and/or upgrade such property by reimbursing the owner for certain costs from the resulting increases in real estate tax revenues; and

WHEREAS, on June 1, 2015, recognizing the need to foster the development, expansion and revitalization of certain real properties, which are vacant, underutilized or obsolete or a combination thereof, a City approved a Tax Increment Redevelopment Plan, designated a Redevelopment Area and adopted Tax Increment Financing as provided under the TIF Act (“Central City TIF District”); and

WHEREAS, the Developer’s proposed project is consistent with the Central City TIF District Redevelopment Plan for the Redevelopment Project Area (the “Redevelopment Plan”) and further conforms to the land uses of the City as adopted; and

WHEREAS, pursuant to Section 5/11-74.4-4(b) of the TIF Act, the City may make and enter into all contracts with property owners, developers, tenants, over lapping taxing bodies, and

others necessary or incidental to the implementation and furtherance of the Redevelopment Plan; and

WHEREAS, pursuant to section 5/11-74.4-4(j) of the TIF Act, the City may incur Project Redevelopment Costs and reimburse developers who incurred redevelopment project costs authorized by a Redevelopment Agreement and further defined in Section 5/11-74.4-3(q) of the TIF Act including those Estimated TIF Eligible Project Cost as herein listed in the attached Exhibit “A” of this Redevelopment Agreement; and

WHEREAS, the Developer has informed the City, and the City hereby specifically finds, that without the financial support that may be provided pursuant to the TIF Act to reimburse some of the Project costs, the Project is not financially feasible and the Project will not move forward; and

WHEREAS, financing the construction of the renovated retail building is consistent with the objectives of the City’s Comprehensive Plan; and

WHEREAS, the parties acknowledge the City, in extending incentives for this Project, is relying on the representations of the Developer contained herein to substantially complete the Project as set forth herein.

NOW, THEREFORE, in consideration of the premises and agreements set forth below, the parties, for and in consideration of the representations relative to the proposed improvements of said real property owned by the Developer, hereby agree as follows:

Section 1. Incorporation of Recitals. The Parties agree that all of the recitals contained in the Preambles to this Agreement are true and correct, and said recitals are hereby incorporated into the Agreement as though they were fully set forth in this Section 1.

Section 2. Contingency. The performance of the Developer set forth in this agreement is premised on the Developer receiving timely approval by the City Council of all planning approvals required to accommodate the Concept Plan, including uses requested by the Developer for the Developer’s Development Project and the timely review and issuance by the City of all Governmental Approvals within its control. Performance hereunder is also premised on the receipt by the Developer, with a copy to the City, of an opinion of the City Attorney as to the validity and enforceability under Illinois law of this Agreement.

Section 3. Obligations/Representations of the Developer.

- a. Upon the approval by the City of the Development Agreement, the Developer shall proceed with the Project as described above. The Project shall be substantially complete within one (1) year of the date of execution of this Development Agreement.
- b. The Developer represents and warrants that it has sufficient funds or financing as necessary to construct the Project.
- c. The Developer shall at all times undertake the Developer’s Development Project, including any related activities in connection therewith, in conformance with this

Agreement, all applicable federal and state laws, rules and regulations and all City Codes. To the extent that the construction of the Developer's Development Project under this Agreement is a "public work" within the meaning of the Prevailing Wage Act of the State of Illinois (820 ILCS 130/0.01 et seq., the "PW Act"), the Developer shall assume the risk of compliance with the PW Act. The PW Act requires contractors and subcontractors performing work on behalf of Developer on the public works portion of the Developer's Development Project to pay laborers, workers and mechanics no less than the current "prevailing rate of wages" (hourly cash wages plus fringe benefits) in the county where the work is performed. IDOL publishes the prevailing wage rates on its website at <http://labor.illinois.gov/>. IDOL revises the prevailing wage rates and any contractor/subcontractor on the Project has an obligation to check the IDOL's website for revisions to the prevailing wage rates. The Developer shall require all contractors and subcontractors performing such work on the Developer's Development Project to comply with all requirements of the PW Act, including, but not limited to, all wage requirements and all notice, record keeping and monthly filing duties. Any agreement of the Developer related to the Developer's Development Project with any contractor or subcontractor shall, to the extent applicable, contain provisions substantially similar to those required of the Developer under this Agreement.

- d. Within fifteen (15) days of receipt of the TIF reimbursement from the City, Developer shall provide proof that Fezziwig's has been reimbursed for its project costs in an amount no less than 89% of what the Developer receives from the City through this Agreement.

Section 4. Obligation of the City. In consideration of the Developer's undertaking of the Project, including the incurring of Reimbursable Redevelopment Project Costs under the Redevelopment Plan, the City hereby pledges and agrees to apply the Incremental Property Taxes generated from Project and deposited into the Special Tax Allocation Fund in accordance with this Agreement to pay Reimbursable Project Costs incurred by the Developer, subject to the following:

- a. The City will reimburse 75% of the incremental EAV generated by the development of this Property until the expiration of this TIF District on June 1, 2038, or until the maximum funding amount is reached, whichever comes first. The developer must supply proof of tax payments, showing the EAV each year.

- b. Eligible Costs City will consider –

Land Acquisition, Renovation of Existing Building, Site Improvements, Legal,
Architectural & Engineering Fees

Total Estimated Eligible Costs \$113,170.12

- c. The Developer shall submit to the City's Director of Finance a request for payment consisting of a sworn written statement setting forth the amount of costs incurred by

the Developer for completion of the Project. Each Request shall be accompanied by such bills, invoices, lien waivers or other evidence as the City may reasonably require for documenting the Developer's costs incurred for the Project. These Requests shall be submitted after January 1st of each year until the total eligible cost tallies to at least \$113,170.12. The Developer may continue to provide Requests until all Project costs have been incurred and the Project is completed.

- d. The City's finance director (or designee as the case may be), shall approve or disapprove a request for payment by written notice to the Developer within 30 days after receipt of the request. Approval of a request will not be unreasonably withheld. If a request is disapproved, the reasons for disapproval will be set forth in writing; and the Developer shall resubmit the request with such additional information as may be required, and the same procedures as set forth herein for the initial submission shall apply for such resubmittals.
- e. Reimbursement of approved Project costs shall be made annually within sixty days upon receipt from the County of the property tax proceeds for the applicable tax year. Approved Project costs shall only be reimbursed to the extent that tax increment is generated by the Property and if there are monies available for such purpose. To the extent money is not available to reimburse the Developer for approved Project costs, such costs shall be reimbursed in subsequent years.
- f. The City and the Developer acknowledge that the determination of the qualification of Eligible Redevelopment Project Costs, the TIF Area and the Redevelopment Plan and Project and, therefore, qualification for payment and/or reimbursement under this Agreement are subject to changes made by amendments to the TIF Act, administrative rules and judicial interpretations during the term of this Agreement. The City has no obligation to the Developer to attempt to modify those decisions but will assist the Developer as to obtaining approval of Eligible Redevelopment Project Cost. The Developer assumes all risk related to qualification of Eligible Redevelopment Project Cost, the Area and the Redevelopment Plan and Project or the Development Project.
- g. Except as otherwise expressly provided herein, the City shall not be obligated to make any payments to any person other than the Developer, nor shall the City obligated to pay any contractor, sub-contractor, mechanic, material man providing services or materials to the Developer for or in respect of the Development Project.
- h. Prior to making an annual payment to the Developer for reimbursement of approved redevelopment project costs, the Developer shall provide evidence that the latest real property tax bill for the Property for the applicable tax year has been paid in full.
- i. The City's Finance Department shall maintain an account of all payment Developer under this Agreement and may set up sub-accounts to track the tax increment, and payments made to the Developer for this Property.

- j. THE CITY'S OBLIGATIONS TO REIMBURSE THE DEVELOPER UNDER THIS AGREEMENT IS A LIMITED OBLIGATION PAYABLE SOLELY FROM INCREMENTAL TAXES GENERATED BY THE PROJECT ON THE PROPERTY AND DEPOSITED IN THE CITY'S FUNDS FROM TIME TO TIME AND SHALL NOT BE A GENERAL OBLIGATION OF THE CITY OR SECURED BY THE FULL FAITH AND CREDIT OF THE CITY.
- k. The City's obligations to reimburse the Developer for eligible TIF Project Costs, pursuant to Section 4 of this agreement, shall terminate upon the occurrence of any of the following:
 - 1. Developer's voluntary or involuntary bankruptcy;
 - 2. Fezziwig's voluntary or involuntary closure of its business;
 - 3. Substantial change in the nature of the Fezziwig's business without the City's prior written approval;
 - 4. Sale of the Developer's building without the City's prior written approval;
 - 5. Sale of Fezziwig's business without the City's prior written approval; or
 - 6. Relocation of Fezziwig's business.
- l. The failure of the Developer to provide any information required in this Agreement shall be considered a material breach of this Agreement and shall be sufficient cause for the City to deny payments under this Agreement to or in respect of the Developer, which payments are expressly conditioned upon the receipt of such information.

Section 5. Indemnification. The Developer shall indemnify and hold harmless the City, its agents, officers and employees against all injuries, deaths, losses, damages, claims, suits, liabilities, judgments, costs and expenses (including any liabilities, judgments, costs and expenses and reasonable attorney's fees) which may arise directly or indirectly from acts or omissions in connection with the Development Project, the Development Area and this Agreement, whether or not a lawsuit is filed. The Developer shall, at its own cost and expense, appear, defend and pay all charges of attorneys, costs and other expenses arising therefrom or incurred in connection therewith. If any judgment shall be rendered against the City, its agents, officers, officials or employees in any such action, the Developer shall, at its own expense, satisfy and discharge the same. This paragraph shall not apply, and the Developer shall have no obligation whatsoever, with respect to any acts of negligence or reckless or willful misconduct on the part of the City or any of its officers, agents, employees or contractors.

In no way limiting the foregoing, the Developer shall also indemnify and hold harmless the City, its agents, officers and employees against all damages, claims, suits, liabilities, judgments, fines, penalties, costs and expenses (including reasonable attorney's fees) which may arise directly or indirectly from any violation of the Illinois Prevailing wage Act, 820 ILCS 130/0.01 *et. seq.*, in connection with the Project.

Section 6. Default and Remedies. Except as otherwise provided in this Agreement, in the event of any default in or breach of any term or conditions of this Agreement by either party or any successor or assign, the defaulting or breaching party (or successor or assign) shall, upon

written notice from the other party, proceed immediately to cure or remedy such default or breach as follows: (a) in the event of a nonmonetary default, within thirty (30) days after receipt of notice, commence to cure or remedy such default, and (b) in the event of a monetary default, within ten (10) days after receipt of notice, commence to cure or remedy such default. In case such cure or remedy is not taken or not diligently pursued, or the default or breach shall not be cured or remedied within a reasonable time, the aggrieved party may institute such proceedings as may be necessary or desirable in its opinion to cure and remedy such default or breach, including without limitation proceedings to compel specific performance by the defaulting or breaching party. If either party shall prevail in any court proceeding to enforce any term, covenant or condition hereof, the non-prevailing party shall reimburse the prevailing party its costs and reasonable attorneys' fees on account of such proceeding.

Section 7. Termination. In the event that the Developer does not commence construction of the addition within six (6) months of the execution of this Agreement, the City may terminate this Agreement. If the City terminates this Agreement in accordance with this paragraph, Developer shall not be entitled to any financial assistance from the City.

In the event that the Project is not substantially completed within one (1) year after the execution of this Agreement, the City may terminate this Agreement. If the City terminates this Agreement in accordance with this paragraph, Developer shall not be entitled to any further financial assistance from the City. In addition, if the Developer fails to complete the Project, the Developer shall reimburse the City for any monies it received pursuant to this Agreement

Section 8. Assignment. This Agreement may not be assigned by the Developer without prior written approval of the City, which shall not be unreasonably withheld.

Section 9. Partial Invalidity. If any section, subsection, term or provision of this Agreement or the application thereof to any party or circumstance shall, to any extent, be invalid or unenforceable, the remainder of said section, subsection, term or provision of this Agreement or the application of the same to parties or circumstances other than those to which it is held invalid or unenforceable, shall not be affected thereby.

Section 10. Waiver. Any party to this agreement may elect to waive any remedy it may have hereunder, provided that no such waiver shall be deemed to exist unless the party waiving such right or remedy, does so in writing. No such waiver shall obligate such party to wave any other right or remedy hereunder, or shall be deemed to constitute a waiver of other rights and remedies hereunder, or shall be deemed to constitute a waiver of other rights and remedies pursuant to this Agreement.

Section 11. Severability. If any section, sub-section, term or provision of this Agreement or the application thereof to any party or circumstance shall, to any extent, be invalid or unenforceable, the remainder of such section, sub-section, term or provision of this Agreement or the application of same, to parties or circumstance other than those to which it is held invalid or unenforceable, shall not be affected thereby.

Section 12. Conflict of Interest. No member of the Corporate Authorities, the Joint Review Board, or any branch of the City’s government who has any power of review or approval of any of Developer’s undertakings, or of the City’s contracting for goods or services for the Property, shall participate in any decisions relating thereto which affect that member’s personal interests or the interests of any corporation or partnership in which that member is directly or indirectly interested. As provided in the TIF Act, any person having such interest shall immediately, upon knowledge of such possible conflict, disclose, in writing, to the City Council the nature of such interest and seek a determination by the City Council with respect to such interest and, in the meantime, shall not participate in any actions or discussions relating to the activities herein proscribed.

Section 13. Force Majeure. The time the Developer is to perform any act under this Agreement shall be extended by a period of time equal to the number of days during which performance of such act is delayed by strikes, lockouts, acts of God, failure or inability to secure materials or labor in a timely fashion or any other cause beyond the reasonable control of the Developer.

Section 14. Agreement Binding on Successors. This Agreement shall be binding on the Developer’s permitted successors and assigns.

Section 15. Counterparts. This Agreement may be executed in multiple counterparts, each of which shall constitute one and the same instrument.

Section 16. Entire Agreement; Amendment. The parties agree that this Agreement constitutes the entire agreement between the parties and that no other agreements or representations other than those contained in this Agreement have been made by the parties. This Agreement shall be amended only in writing and effective when signed by the authorized representatives of both parties.

Section 17. Miscellaneous. Developer represents that signee has the authority to enter into this Agreement.

Section 18. Notices. All notices, demands, requests, consents, approvals or other instruments required or permitted by this Agreement shall be in writing and shall be executed by the party or an officer, agent or attorney of the party, and shall be deemed to have been effective as of the date of actual delivery, if delivered personally, or as of the third (3rd) day from and including the date of posting, if mailed by registered or certified mail, return receipt requested, with postage prepaid, addressed as follows:

To the Developer:

Attention: Gregory Muren
Metro Inflatables, LLC
114 North Vine Street
O’Fallon, IL 62269

To the City:

Attention: City Clerk
City of O’Fallon
255 South Lincoln Avenue
O’Fallon, IL 62269

IN WITNESS WHEREOF, the City and Developer have caused this Agreement to be

Attachment A

Extensive Renovations to 225 W. 1st Street O'Fallon, IL 62269

Source	Amount	Services and details	Date	Date Paid	Paid by
ADT Security	\$ 510.97	New ADT Pulse security system	6/26/2015	6/26/2015	Credit card
City of O'Fallon	\$ 250.00	Zoning Amendment & Planned Use Application	4/1/2015	4/1/2015	Check
City of O'Fallon	\$ 86.79	Zoning Fee (\$35) and Sign Fee (\$50)	4/16/2015	4/16/2015	Credit card
City of O'Fallon	\$ 425.00	Building permits for 225 W. 1st Street remodel	5/14/2015	5/18/2015	Check
Demond Signs	\$ 640.00	4 x 8 sign for store front	5/15/2015	5/26/2015	Check
Environs Architects & Planners	\$ 2,400.00	Professional services and construction documents	5/6/2015	5/26/2015	Check
Hayden Homeworks	\$ 5,425.00	Complete ductwork replacement materials and labor	7/21/2015	8/13/2015	Check
Hayden Homeworks	\$ 429.00	Fabricate stainless steel pieces for gas range and install duct work	9/13/2015	10/13/2015	Check
Home Depot	\$ 143.41	Door lockset for new front door	5/4/2015	5/4/2015	Credit card
Home Depot	\$ 323.40	New pantry door and framing btwn kitchen and classroom	6/20/2015	6/20/2015	Credit card
Home Depot	\$ 102.22	Ceiling paint and roller covers	6/25/2015	6/25/2015	Cash
Home Depot	\$ 170.54	Paint for interior walls and	6/26/2015	6/26/2015	Credit card
Home Depot	\$ 93.38	Interior paint and supplies	6/27/2015	6/27/2015	Credit card
Home Depot	\$ 385.02	Cast iron dbl sink for classroom, faucet and handles	7/1/2015	7/1/2015	Credit card
Home Depot	\$ 31.24	Interior paint	7/3/2015	7/3/2015	Cash
Home Depot	\$ 535.83	4 ceiling fans, down rods, chains for carriage house	7/26/2015	7/26/2015	Credit card
Jacob Adams Construction	\$ 13,374.00	Phase 1 of construction, demolition and framing	5/4/2015	5/4/2015	Check
Jacob Adams Construction	\$ 14,200.00	Phase 2 of construction	5/16/2015	5/16/2015	Check
Jacob Adams Construction	\$ 7,250.00	Phase 3 of construction	5/16/2015	5/16/2015	Check
Jacob Adams Construction	\$ 750.00	2 adtl transoms and trim, rear steps, cleanup and removal	6/12/2015	6/12/2015	Check
Jacob Adams Construction	\$ 2,200.00	Install kitchen cabinets, install countertops, cabinets in classroom	6/12/2015	6/12/2015	Check
Jacob Adams Construction	\$ 9,516.00	Install priv fence overlay, add base cab, drywall finish labor, balance of flooring, balance of cabinet project, install two add transoms & trim, install trims, install rear steps, add cabinet, extra 20 yd dumpster, add upstairs door, install registers	7/6/2015	7/6/2015	Check
Jacob Adams Construction	\$ 75.00	Relocation of thermostat	12/31/2015	12/31/2015	Check
Klein's Brand Source	\$ 780.08	42" Glass Canopy over 5 burner oven	4/8/2015	4/8/2015	Credit card
Light Brite	\$ 2,500.00	Down payment on all lighting fixtures for remodel	6/4/2015	6/5/2015	Check
Light Brite	\$ 2,495.03	Balance of invoice #349264	6/26/2015	6/26/2015	Check
Light Brite	\$ 78.16	Additional overhead track fixtures	7/27/2015	7/27/2015	Credit card
Lowe's	\$ 174.18	96" toe kick, 24" base cabinet, ADA braille restroom sign, locking mailbox	6/15/2015	6/15/2015	Credit card
Lowe's	\$ 259.43	30" base cabinet, 4 cases marcona hickory laminate flooring	6/17/2015	6/17/2015	Credit card
Maxson Service	\$ 10,299.90	Labor and materials for rough-in and trim of plumbing	8/11/2015	8/28/2015	Check
Maxson Service	\$ 1,876.60	Labor and materials associated with upstairs water and drain	8/11/2015	8/28/2015	Check
Maxson Service	\$ 146.11	Labor and materials for stove hookup	8/11/2015	8/28/2015	Check
Moore Asphalt	\$ 6,300.00	Level up low spots, add 2.5" asphalt and roll/tamp carriage house	12/17/2015	12/17/2015	Check
True Value	\$ 408.16	Ceiling paint, wall paint and painting supplies	6/24/2015	6/24/2015	Cash
True Value	\$ 36.65	KILZ 2 gallons	6/25/2015	6/25/2015	Cash
True Value	\$ 148.83	5 Gallons pastel base	6/26/2015	6/26/2015	Cash
Webstaurant	\$ 2,616.07	40lb grease trap, 16 ga. Triple stainless sink, stainless wall mounted hand sink, natural gas 5 burner oven, wall-mounted spray head for triple sink	6/17/2015	6/17/2015	Credit card
Windsor Electric	\$ 7,100.00	50% down payment on electrical work rewire to 200amp service, new panel,	5/17/2015	5/21/2015	Check
Windsor Electric	\$ 16,600.00	Balance of original electrical services \$23,700, all LED lighting systems	7/22/2015	7/24/2015	Check
Windsor Electric	\$ 1,193.72	A/C circuit, furnace circuit, 2 track lights, microwave circuit, dimmer switches	7/24/2015	9/2/2015	Check
Windsor Electric	\$ 840.40	Install 4 ceiling fans in barn, install outdoor emergency light on rear of store	9/22/2015	10/13/2015	Check
TOTAL	\$113,170.12				



M E M O R A N D U M

TO: Community Development Committee
FROM: Justin Randall, Senior City Planner
THROUGH: Ted Shekell, Director of Community Development
DATE: June 13, 2016
SUBJECT: Milburn Estates, 1st Addition - Final Plat (1st Reading)

Background

The applicant, Milburn Road, LLC, is proposing a Final Plat of the 1st Addition of Milburn Estates subdivision, consisting of 20 single-family homes on 17.04 acres. This is 1st Addition of a larger development located south of Milburn School Road, south of the Milburn Campus of OTHS.

The proposed final plat is consistent with the approved preliminary plat and improvement plans.

Budgetary Impact

There will be an annexation fee paid to the City of \$2,250 per lot.

Legal Impact

None

Recommendation

Community Development and Public Work staff recommend the 1st Addition of Milburn Estates Final Plat for approval.

Attachments

Aerial
Preliminary Plat
Final Plat

Community Development Department
255 South Lincoln Avenue O'Fallon, IL 62269 ☎ P: 618.624.4500 x 4 ☎ F:618.624.4534

S16-04: Milburn Estates 1st Addition - Final Plat



Provided by East-West Gateway Council of Governments, imagery flown by SURDEX

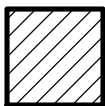

Subject Property

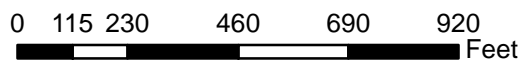

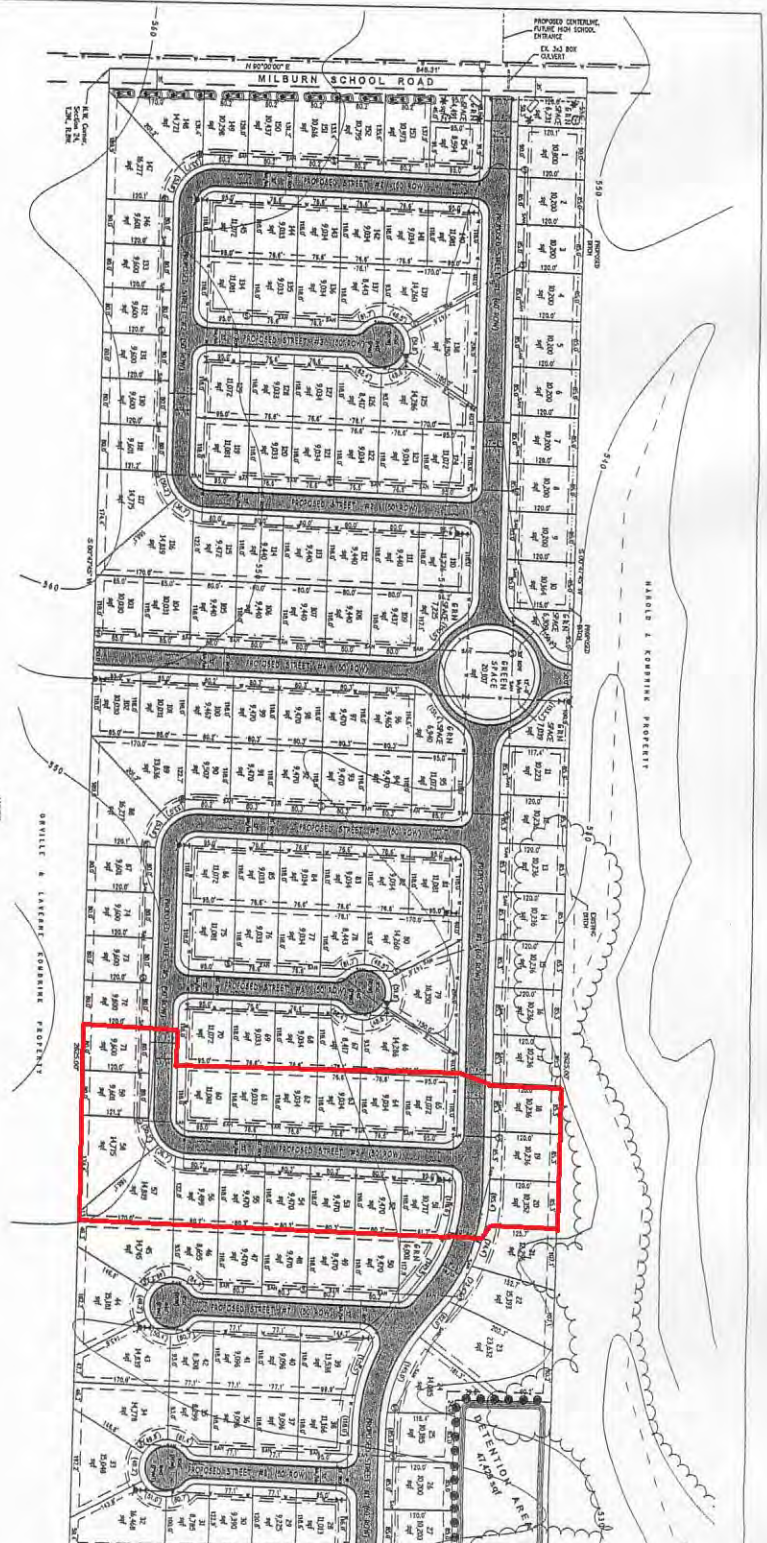

SUBDIVISION INFORMATION
 154 LOTS TOTAL
 76.6 minimum frontage

TOTAL AREA = 51.0 ACRES
 AREA IN LOTS = 38.2 ACRES
 DETENTION AREA = 11 ACRES
 GREEN SPACE AREA = 1.5 ACRES

SAINTARY CENTER
 CANTONVILLE TOWNSHIP SEWER
 WATER
 CITY OF FALLON
 CANTONVILLE TOWNSHIP

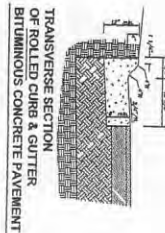

TRANSVERSE SECTION OF ROLLED CURB & GUTTER WITH BITUMINOUS CONCRETE PAVEMENT

PAVEMENT ALTERNATIVES

- 1. 1.5" PORTLAND CEMENT CONCRETE
- 2. 4" ASPHALT
- 3. 4" PORTLAND CEMENT CONCRETE
- 4. 1.5" PORTLAND CEMENT CONCRETE
- 5. 4" ASPHALT
- 6. 1.5" PORTLAND CEMENT CONCRETE
- 7. 4" ASPHALT

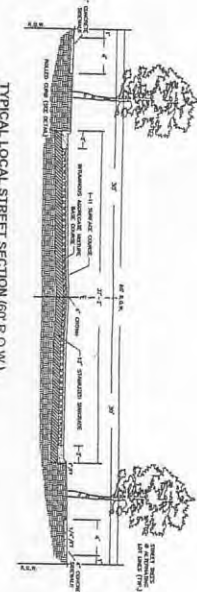
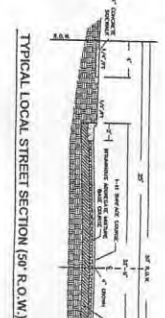

- NOTE:**
1. SANITARY SEWER LAYOUT SHOWS POSSIBLE PATHS. FINAL LAYOUT TO BE DETERMINED ON CONSTRUCTION PLANS AFTER UTILITY HAVE BEEN DETERMINED. THE SANITARY SEWER SHALL BE 18" DIA. TO BE PROVIDED WITH CONSTRUCTION PLANS.
 2. SPACINGS CALCULATED WITH 1500 GPM/SQ INCH AND 1500 GPM/SQ INCH TO BE PROVIDED WITH CONSTRUCTION PLANS.
 3. ALL LOT FRONTAGES TO HAVE 40' BUILDING SETBACK AND 40' UTILITY & DRAINAGE EASEMENT.
 4. REAR AND SIDE YARD EXEMPTIONS ARE TO BE CITY UTILITY AND DRAINAGE USE ONLY.
 5. WATER MAIN ALONG PROPOSED STREET #1 TO BE 6" DIA. ALL OTHER MAIN TO BE 8" DIA.
 6. THE DEVELOPMENT IS NOT WITHIN A FEMA FLOODPLAIN.
 7. ALL LANDSCAPE AND VEGETATION EXCEPT ASPKS TO BE MAINTAINED BY HOME OWNERS ASSOCIATION.
 8. LANDSCAPE AND VEGETATION EXCEPT ASPKS NOT INCLUDED IN LOT AREA SHOWN HEREON.

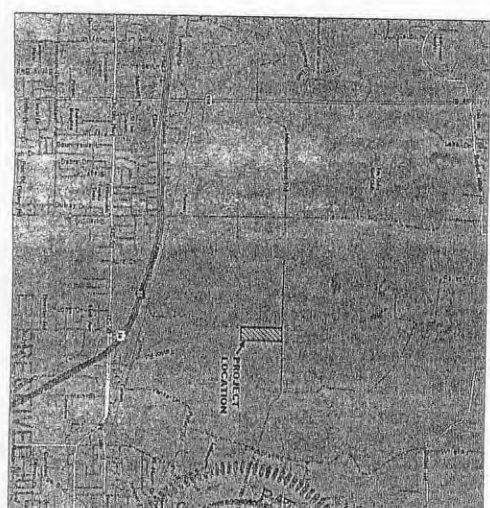

NETEMEYER ENGINEERING ASSOCIATES, INC.
 3300 Highline Road Avon, IL 62216
 PHONE: (618) 228-7816
 FAX: (618) 228-7900

PROJECT LOCATION

DATE: 07/2007

SCALE: 1" = 50'

PROJECT: MILBURN ESTATES

PREPARED BY: [Signature]

CHECKED BY: [Signature]

DATE: 7/2007

SCALE: 1" = 50'

MILBURN ESTATES
 Part of the N.W. 1/4 of Section 24, T.2 N., R.8 W. 3rd P.M.
 St. Clair County, Illinois

O'FALLON DEVELOPMENT GROUP, L.L.C.
 791 Wall Street Suite 100 O'Fallon, Illinois 62269
 Phone: (618) 632-2500

SURVIVOR/ENGINEER:
NETEMEYER ENGINEERING ASSOCIATES, INC.
 3300 Highline Road Avon, IL 62216
 PHONE: (618) 228-7816
 FAX: (618) 228-7900

MILBURN ESTATES - 1st ADDITION

Part of the Northwest Quarter of Section 24, Township 2 North, Range 8 West of the Third Principal Meridian, St. Clair County, Illinois

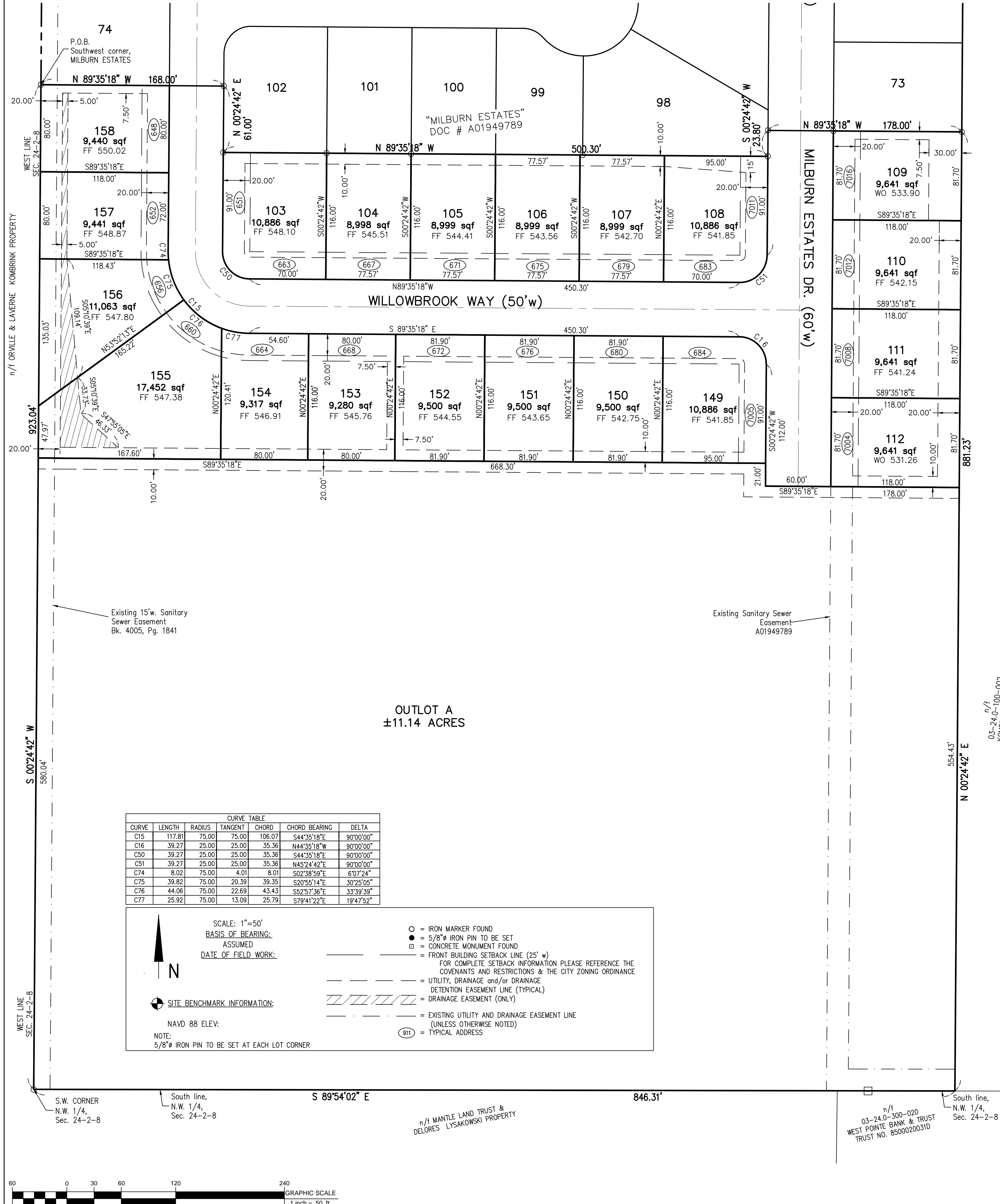

PERIMETER DESCRIPTION:

Part of the Northwest Quarter of Section 24, Township 2 North, Range 8 West of the Third Principal Meridian, St. Clair County, Illinois, described as follows:

Beginning at the Southwest Corner of "MILBURN ESTATES" as recorded in Plat Book _____, Page _____ of the St. Clair County, Illinois records; thence, S.00°24'42"W, (bearing assumed) along the West line of said Northwest Quarter, 923.04 feet to the Southwest Corner of said Northwest Quarter; thence, S.89°35'18"E, along the South Line of said Northwest Quarter, 846.31 feet; thence, N.00°24'42"E, 861.23 feet to the Southeast corner of said "MILBURN ESTATES"; thence along the Southerly boundary of said "MILBURN ESTATES" as follows: N.89°35'18"W, 178.00 feet; thence, S.00°24'42"W, 23.80 feet; thence, N.89°35'18"W, 500.30 feet; thence, N.00°24'42"E, 61.00 feet; thence, N.89°35'18"W, 168.00 feet to the Point of Beginning, containing 17.04 acres, more or less.

NOTE:

The approval and certification of this plat by the City of O'Fallon, the subdivider, and the surveyor/engineer does not obligate them to perform any maintenance of any drainage easement in this subdivision, nor does it obligate them to the acceptance of any storm water drainage way, structure or improvement. It is the intent of the City, subdivider and surveyor/engineer that the individual lot owners shall maintain that part of any drainage easement shown hereon lying within the boundary of their property. Any storm or seep water drainage pipe 12" diameter or smaller along with inlets and other items appurtenant to these drainage pipes shall be privately owned and maintained by the homeowner's association established for this subdivision.

SURVEYOR'S CERTIFICATE:

I, Patrick R. Netemeyer, Illinois Professional Land Surveyor No. 2704, hereby certify that this is a true and correct plat of survey made under my supervision at the request of the owners. I further certify that the property herein described is not within a flood hazard area as indicated by the Federal Emergency Management Agency. I further certify that the tract shown hereon is within the corporate limits of the City of O'Fallon, which has adopted a city plan and is exercising the special powers authorized by Division 12 of Article 11 of the Municipal Code, and that the tract is not within 1-1/2 miles of any other city, town or village which has adopted a city plan and is exercising the special powers authorized by said Division 12 of Article 11 of the Illinois Municipal Code. Given under my hand and seal at 3300 Highline Road, Aviston, Il., this _____ day of _____, 2016.

Patrick R. Netemeyer I.P.L.S. No. 2704
Expiration Date: November 30, 2016
NETEMEYER ENGINEERING ASSOC., INC.
3300 Highline Road
Aviston, Illinois 62216
phone: (618) 228-7816

It is not warranted that this plat contains complete information regarding dedications, easements, rights of way, Federal Emergency Management Agency Flood Zones, encroachments, building locations, occupation lines, or other encumbrances. For complete information, a title opinion or commitment for title insurance and FEMA maps should be obtained, reviewed, and upon request additional information can be obtained on this plat. This professional service conforms to the current Illinois minimum standards for a boundary survey.

I do hereby certify that the following agencies were properly notified if required and to the best of my knowledge approve this project:

- Illinois Historic Preservation Agency (HPA - archaeological)
- Illinois Department of Natural Resources (IDNR-endangered species)
- Illinois Department of Natural Resources - Division of Water Resources (IDNR-DWR - stream hydraulics)
- Soil Conservation Service (SCS - land use)
- U.S. Army Corps of Engineers (USACE - clean water act/stream hydraulics)
- Illinois Environmental Protection Agency (IEPA - storm water permit)
- St. Clair County Department of Roads and Bridges (entrance permit)
- Illinois Dept. of Transportation Div. of Highways (DOT - entrance permit)
- U.S. Department of Agriculture (USDA - prime farm land)

Patrick R. Netemeyer I.P.L.S. No. 2704
Expiration Date: November 30, 2016

LAND SURVEYOR / ENGINEER:
NETEMEYER ENGINEERING ASSOCIATES, INC.
IL. PROF. DESIGN FIRM (LS/PE/SE) 184-001027
3300 HIGHLINE ROAD
AVISTON, IL 62216-1018
PH: 618-228-7816

RETURN PLAT TO OWNER:
Milburn Road L.L.C.
774 Sunset Blvd., Suite 100
O'Fallon, IL 62269

NOTES:

- FINISHED FLOOR ELEVATIONS SUBJECT TO REVISION BY PROFESSIONAL ENGINEER AFTER AS-BUILT CONDITIONS ARE DETERMINED.
- FF = MINIMUM FOUNDATION OPENING ELEVATION ON STANDARD LOT
- WO = MINIMUM FOUNDATION OPENING ELEVATION ON WALK-OUT LOT (FF - 8')
- DECK = MINIMUM FOUNDATION OPENING ELEVATION ON DECK LOT (FF-6')
- A Private Drain Facility Easement is shown on this plat the boundary lines of which are coincidental with all backyard public utility drainage easements shown, and shall be subordinate to and shall not be used to interfere with the public drainage easement provided at the same location. The Private drain facilities easement shall allow for installation and maintenance of underground basement sump drain and low volume rainfall runoff system infrastructure for adjoining and nearby lots within the subdivision installed subject to all applicable codes. No land disturbance or change of grade may occur without City approval nor in anyway that interferes with the use of the public drainage easement. The Private drain facility easement and facilities therein shall be maintained by the established subdivision homeowner's association in the same manner as other common facilities within the platted subdivision.
- THIS SUBDIVISION SHALL BE SUBJECT TO MILBURN ESTATES COVENANTS AND RESTRICTIONS RECORDED IN DOCUMENT _____ OF THE ST. CLAIR COUNTY, ILLINOIS RECORDS.

State of Illinois)
County of St. Clair)ss

I, the undersigned, a member of Milburn Road L.L.C., an Illinois Corporation, being the owner of the land hereon described, have caused the same to be surveyed and subdivided in the manner shown by the within plat and said subdivision is to be known as "MILBURN ESTATES - 1st ADDITION." It is not contemplated that any appreciable change will be made in the flow of surface water from said land by the surveying and plating into lots. All rights of way and easements shown hereon are hereby dedicated to the use of the public forever including the release and waiver of the right of homestead under the Homestead Exemption laws of the State of Illinois. The building lines as shown are hereby established.

I further certify that the property platted hereon is within O'Fallon Grade School District No. 90, O'Fallon High School District No. 203 and Southwestern Illinois College District No. 522.
In witness whereof, we have set our hands this _____ day of _____, 2016.

Member
Milburn Road L.L.C.
774 Sunset Blvd., Suite 100
O'Fallon, IL 62269

State of Illinois)
County of St. Clair)ss

I, _____, Notary Public in and for said county in the state aforesaid, do hereby certify that _____ Member of Milburn Road L.L.C., is personally known to me to be the same person whose name is subscribed to the foregoing instrument as such owner, appeared before me in person this day and acknowledged that he has signed and delivered the said plat as his own free and voluntary act for the uses and purposes herein set forth.

Given under my hand and seal this _____ day of _____, 2016.

Notary Public

State of Illinois)
County of St. Clair)ss

We, the undersigned, professional engineer for this development and members of Milburn Road L.L.C., the owner, do hereby state that to the best of our knowledge and belief the drainage of surface waters will not be changed by the construction of this subdivision if completed in accordance with the plans prepared by Netemeyer Engineering Assoc., Inc., latest revision, as approved by the City or that if such surface water drainage will be changed, reasonable provision has been made for collection and diversion of such surface waters into public areas, or drains which the subdivider has a right to use, and that such surface waters will be planned for in accordance with generally accepted engineering practices so as to reduce the likelihood of damage to the adjoining property because of the construction of this subdivision.

Member
Milburn Road L.L.C.
774 Sunset Blvd., Suite 100
O'Fallon, IL 62269

Patrick R. Netemeyer I.R.P.E. No. 37441
Expiration Date: November 30, 2017

State of Illinois)
County of St. Clair)ss

Examined and approved by the City Council of the City of O'Fallon, Illinois and accepted by resolution No. _____ dated this _____ day of _____, 2016.

Mayor

City Clerk

State of Illinois)
County of St. Clair)ss

Approved by Mapping and Platting this _____ day of _____, 2016.

Director of Mapping and Platting

State of Illinois)
County of St. Clair)ss

This plat has been reviewed for 911 implementation.

911 Coordinator Date

State of Illinois)
County of St. Clair)ss

I, the undersigned, County Clerk of St. Clair County, Illinois, do hereby certify that I find no unpaid taxes against any of the real estate included within this plat.
In witness whereof, I have hereunto set my hand and affixed the seal of my office this _____ day of _____, 2016.

County Clerk





MEMORANDUM

TO: Community Development Committee
FROM: Justin Randall, Senior City Planner
THROUGH: Ted Shekell, Director of Community Development
DATE: June 13, 2016
SUBJECT: Parkview Meadows – Phase 1 - Final Plat (1st Reading)

Background

The applicant, Fulford Homes, is proposing a Final Plat of Parkview Meadows – Phase 1, consisting of 24 single-family homes on 7.76 acres. This is first final plat of an 18.18-acre, 49 lot subdivision located 0.25-mile north of State Street on the east side of Obernuefemann Road (just north of the Family Sports Park entrance).

The proposed final plat is consistent with the approved preliminary plat and improvement plans.

Budgetary Impact

The subdivision will have a park land fee of \$865 per lot.

Legal Impact

None

Recommendation

Community Development and Public Work staff recommend the Parkview Meadows Phase 1 Final Plat for approval.

Attachments

Aerial
Preliminary Plat
Phase 1 Final Plat

S16-05: Parkview Meadows Phase 1 - Final Plat



Provided by East-West Gateway Council of Governments, imagery flown by SURDEX

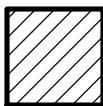

Subject Property

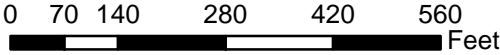

PRELIMINARY PLAT PARKVIEW MEADOWS

PART OF THE NORTH 1/2 OF SECTION 30, IN TOWNSHIP 2 NORTH, RANGE 7
WEST OF THE 3RD PRINCIPAL MERIDIAN, ST. CLAIR COUNTY, ILLINOIS

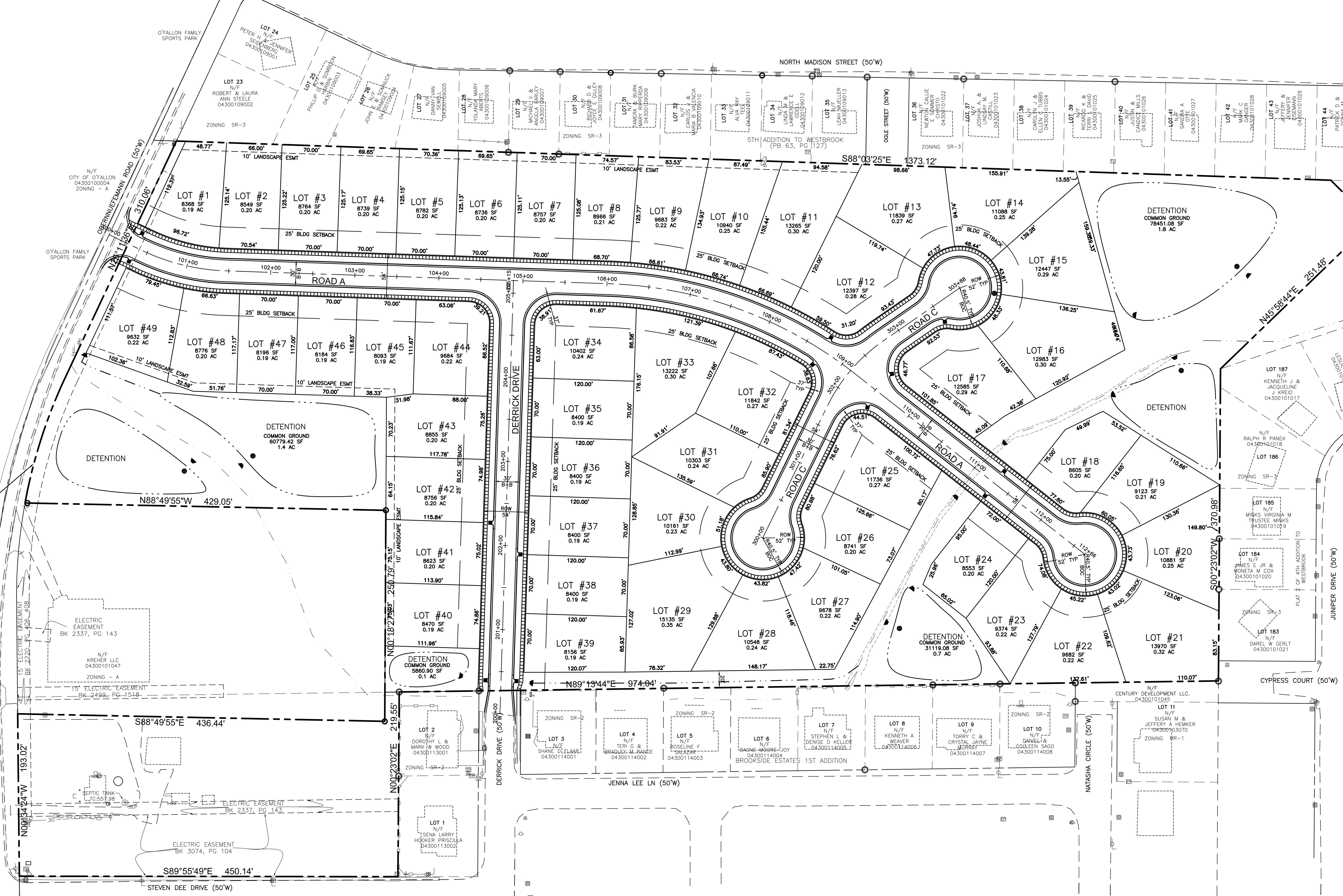
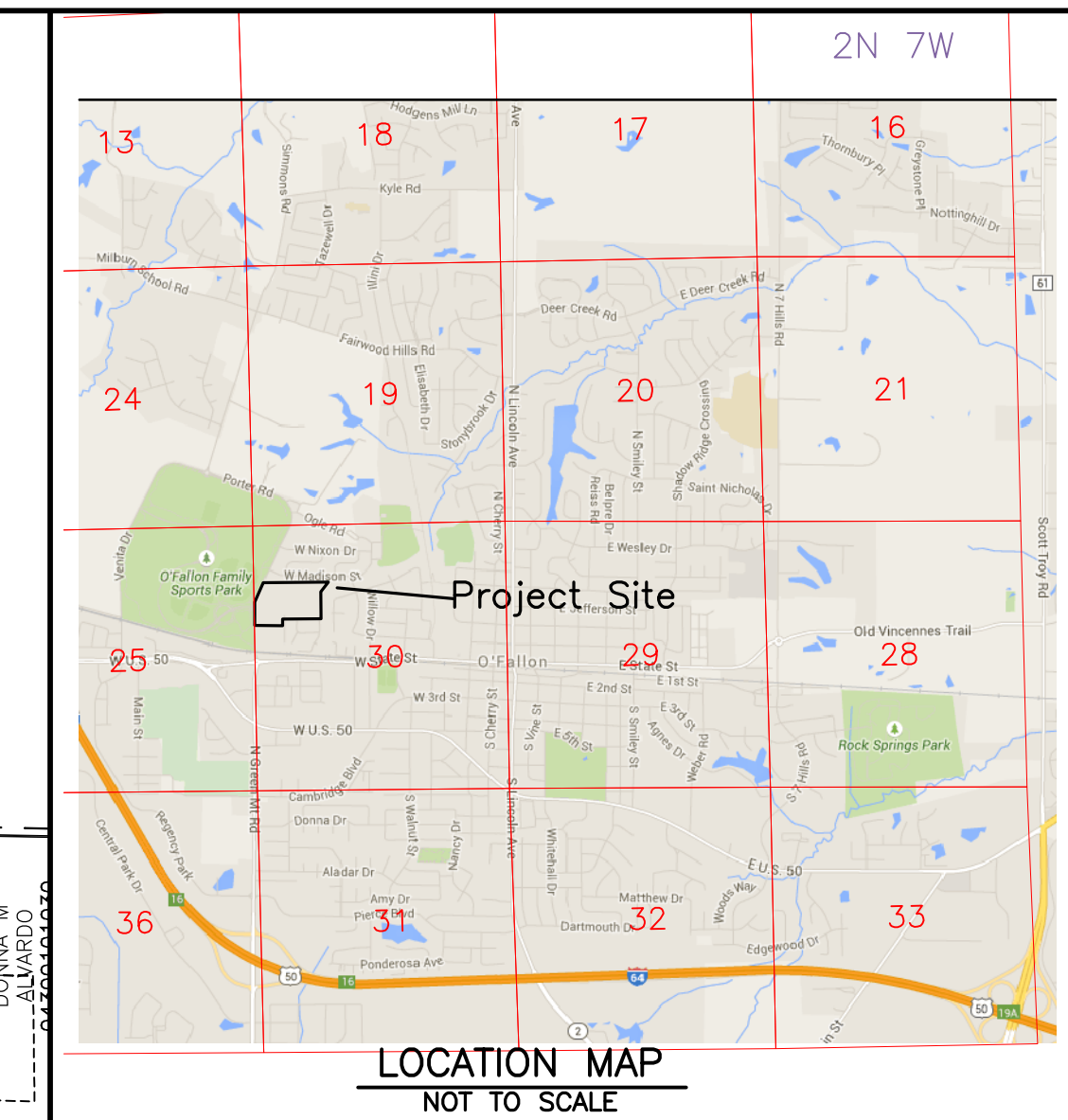

SITE DATA	
TOTAL DEVELOPMENT	
HOUSING PRODUCT	= SINGLE FAMILY
AVG LOT SIZE	= 9,957 SF (0.23 AC)
MIN LOT SIZE	= 8,093 SF (0.19 AC)
MAX LOT SIZE	= 15,135 SF (0.35 AC)
GROSS AREA	= 792,040 SF (18.18 AC)
PUBLIC ROW AREA	= 126,859 SF (2.91 AC)
NET AREA	= 487,869 SF (11.20 AC)
NUMBER OF LOTS	= 49
DENSITY	= 2.69 UNITS/ACRE
COMMON GROUND AREA	= 177,312 SF (4.07 AC)
NOTES:	
STREET LIGHTS SHALL BE INSTALLED BY AMEREN IP & COORDINATED BY THE DEVELOPER.	
ALL UTILITIES SHALL BE UNDERGROUND	
EASEMENTS NOT SHOWN FOR CLARITY. EASEMENTS WILL BE PROVIDED AT SUBDIVISION PERIMETER, LOT FRONT YARDS, AND AS NECESSARY TO ACCOMMODATE ALL UTILITIES.	
ALL PEDESTALS AND TRANSFORMERS SHALL BE LOCATED A MINIMUM OF 15' FROM CITY UTILITIES.	
OWNER:	KAREN BROWN 513 TURTLE CREEK CT O'FALLON, IL 62269 PHONE: 618.632.7231
DEVELOPER:	CHRIS MATTEO FULFORD HOMES 1116 HARTMAN LANE SHILOH, IL 62221 PHONE: 618.632.5779
ENGINEER:	DAVID DILLON, PE 062-047964 WOOLPERT, INC 343 FOUNTAINS PARKWAY, SUITE 100 FAIRVIEW HEIGHTS, IL 62208 PHONE: 618.632.7004
LAND SURVEYOR:	KELLY HARRIS, PLS 3749 WOOLPERT, INC 343 FOUNTAINS PARKWAY, SUITE 100 FAIRVIEW HEIGHTS, IL 62208 PHONE: 618.632.7004
EXISTING ZONING:	AGRICULTURAL (A)
PROPOSED ZONING:	SR-2 (SINGLE FAMILY)
PROPOSED ZONING REQ:	8,000 SF MIN LOT 60' MIN LOT WIDTH 100' AVG LOT DEPTH
FLOODPLAIN:	FIRM MAP NUMBER 1716300206D EFFECTIVE DATE NOVEMBER 5, 2003 ZONE "X" (NO SHADING)
SEWAGE DISPOSAL:	CITY OF O'FALLON
WATER SUPPLY:	CITY OF O'FALLON
ELECTRIC SERVICE:	AMEREN IP PROPOSED UNDERGROUND SERVICE
GAS SERVICE:	AMEREN IP

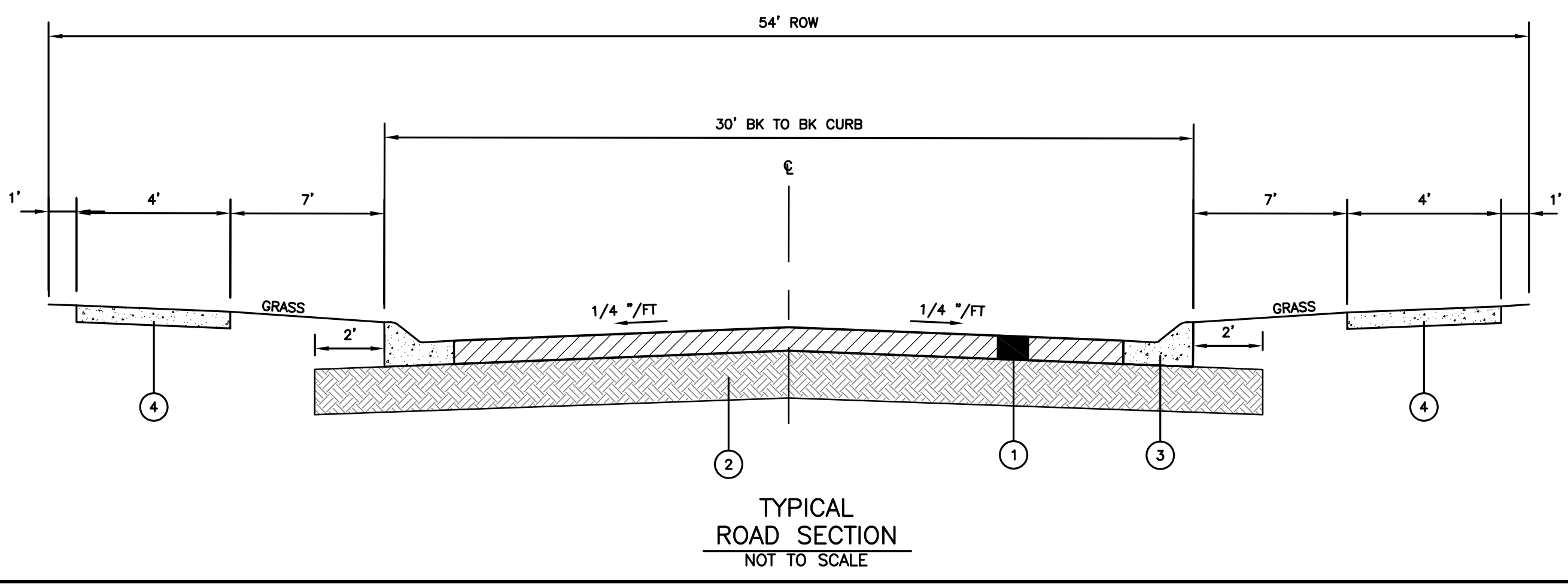

- TYPICAL ROADWAY SECTION LEGEND**
- 7" NON-REINFORCED PCC PAVEMENT OR 7" BIT CONC
 - 12" STABILIZED SUBGRADE
 - 2' MOUNTABLE CONCRETE CURB & GUTTER PER CITY OF O'FALLON STANDARDS
 - 4" THICK PCC SIDEWALK (6" THICK THROUGH DRIVEWAYS)

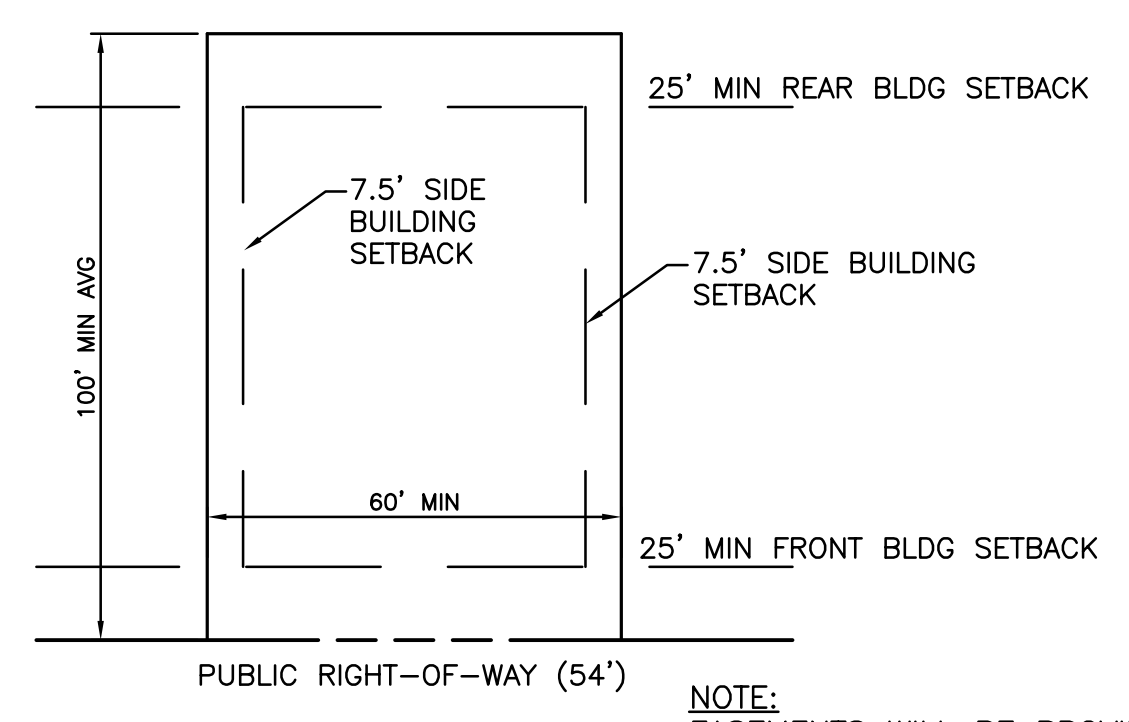

NOTE:
EASEMENTS WILL BE PROVIDED AT SUBDIVISION PERIMETER, LOT FRONT YARDS, AND AS NECESSARY TO ACCOMMODATE ALL UTILITIES.

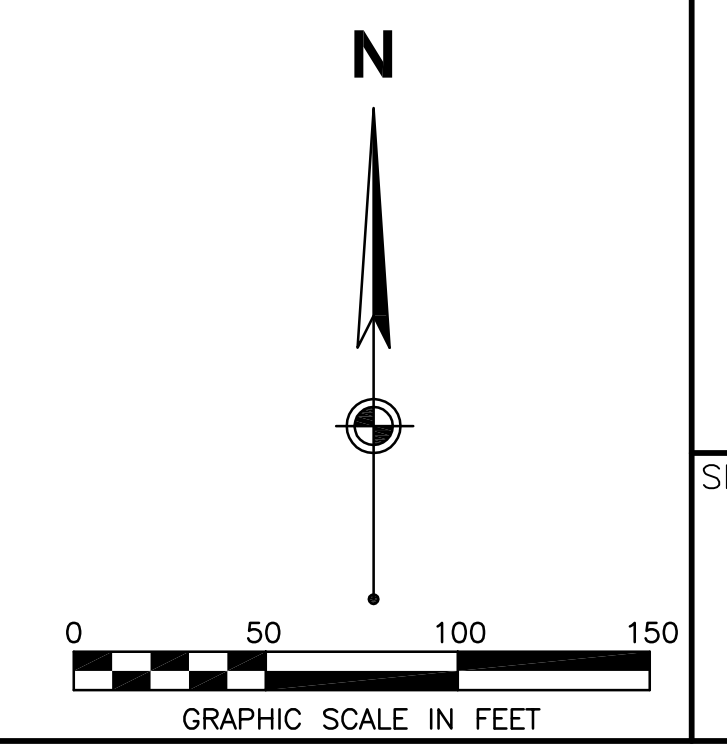

	PROJECT NO: 75555 DATE: 7/20/15 DES: DR. DR: CKD.
	1116 Hartman Lane Shiloh, Illinois 62221 618.632.5779 ENGINEER: DAVID M. DILLON, PE ENGINEER/SURVEYOR
WOOLPERT Survey & Engineering, Inc. 373 Fountain Parkway, Suite 100 Fairview Heights, Illinois 62208 618.632.7004 ENGINEER: DAVID M. DILLON, PE	SHEET NO. 1 of 3

G:\DE\Clients\Fulford Homes\Brown Site PRE PLAT.dwg Plotted By: hmp, Joe Plot: July 20, 2015, 2:29:14 PM

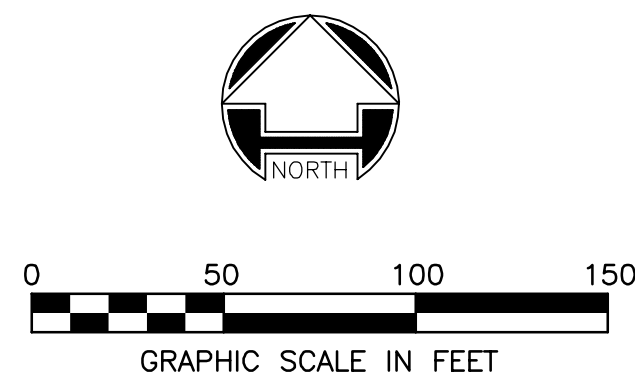

FINAL PLAT OF PARKVIEW MEADOWS PHASE 1

A PART OF THE NORTHWEST QUARTER OF SECTION 30,
TOWNSHIP 2 NORTH, RANGE 7 WEST OF THE 3RD PRINCIPAL MERIDIAN,
ST. CLAIR COUNTY, ILLINOIS.

LEGEND:

- OVERALL BOUNDARY
- PHASE 1 LIMITS
- - - EXISTING LOT/PARCEL LINE
- - - EXISTING RIGHT OF WAY LINE
- - - EXISTING EASEMENT LINE
- - - PROPOSED LOT LINE
- - - PROPOSED RIGHT OF WAY LINE
- - - PROPOSED EASEMENT LINE
- - - PROPOSED 25' SETBACK LINE
- - - SECTION LINES
- SET R.R. SPIKE/NAIL IN ASPHALT OR IRON PIN W/CAP IN SOIL OR CUT CROSS IN CONCRETE
- REBAR FOUND
- IRON PIPE FOUND
- NAIL FOUND
- SPIKE FOUND
- CHISELED CROSS FOUND
- BRASS PLUG FOUND
- BENCH MARK FOUND/SET
- P.O.B. POINT OF BEGINNING
- P.O.C. POINT OF COMMENCEMENT
- R.O.W. RIGHT-OF-WAY
- WIDTH
- ADDRESS LABEL

SITE MAP

NOT TO SCALE

POINT BEING 660.0' NORTH OF THE NORTH LINE OF LOT 13

N/4 CITY OF FALLON 04300100004 ZONING - A

15' ELECTRIC EASEMENT BK 2220, PG 406, 408

STM MH 512 TC:555.82

N24°50'56"E 310.06'

LEN=156.53' R=610.13' CH BRG=N17°29'57"E CH LEN=156.10'

EAST RIGHT-OF-WAY LINE

30' LANDSCAPE & UTILITY EASEMENT HEREBY GRANTED

FOUND IRON PIPE

R=612.27' R. CHB=S 07°15'09" W R. L=121.61'R.

ELECTRIC EASEMENT BK 2337, PG 143

N/4 KREHER LLC 04300101047 ZONING - A

15' ELECTRIC EASEMENT BK 2499, PG 1918

P.O.B. EXCEPTION PARCEL 2

S 87°24'12" E 26.08' R.

P.O.C. EXCEPTION PARCEL

SOUTHWEST CORNER OF THE NORTHWEST 1/4 OF SECTION 30

LOT 1 8787 SF 0.20 AC

LOT 2 8511 SF 0.20 AC

LOT 3 8568 SF 0.20 AC

LOT 4 8478 SF 0.19 AC

LOT 5 8509 SF 0.20 AC

LOT 6 8507 SF 0.20 AC

LOT 7 8506 SF 0.20 AC

LOT 8 8834 SF 0.20 AC

LOT 9 8506 SF 0.20 AC

LOT 10 8506 SF 0.20 AC

LOT 11 8506 SF 0.20 AC

LOT 12 8506 SF 0.20 AC

LOT 13 8506 SF 0.20 AC

LOT 14 8506 SF 0.20 AC

LOT 15 8506 SF 0.20 AC

LOT 16 8506 SF 0.20 AC

LOT 17 8506 SF 0.20 AC

LOT 18 8506 SF 0.20 AC

LOT 19 8506 SF 0.20 AC

LOT 20 8506 SF 0.20 AC

LOT 21 8506 SF 0.20 AC

LOT 22 8506 SF 0.20 AC

LOT 23 8506 SF 0.20 AC

LOT 24 8506 SF 0.20 AC

LOT 25 8506 SF 0.20 AC

LOT 26 8506 SF 0.20 AC

LOT 27 8506 SF 0.20 AC

LOT 28 8506 SF 0.20 AC

LOT 29 8506 SF 0.20 AC

LOT 30 8506 SF 0.20 AC

LOT 31 8506 SF 0.20 AC

LOT 32 8506 SF 0.20 AC

LOT 33 8506 SF 0.20 AC

LOT 34 8506 SF 0.20 AC

LOT 35 8506 SF 0.20 AC

LOT 36 8506 SF 0.20 AC

LOT 37 8506 SF 0.20 AC

LOT 38 8506 SF 0.20 AC

LOT 39 8506 SF 0.20 AC

LOT 40 8506 SF 0.20 AC

LOT 41 8506 SF 0.20 AC

LOT 42 8506 SF 0.20 AC

LOT 43 8506 SF 0.20 AC

LOT 44 8506 SF 0.20 AC

LOT 45 8506 SF 0.20 AC

LOT 46 8506 SF 0.20 AC

LOT 47 8506 SF 0.20 AC

LOT 48 8506 SF 0.20 AC

LOT 49 8506 SF 0.20 AC

LOT 50 8506 SF 0.20 AC

LOT 51 8506 SF 0.20 AC

LOT 52 8506 SF 0.20 AC

LOT 53 8506 SF 0.20 AC

LOT 54 8506 SF 0.20 AC

LOT 55 8506 SF 0.20 AC

LOT 56 8506 SF 0.20 AC

LOT 57 8506 SF 0.20 AC

LOT 58 8506 SF 0.20 AC

LOT 59 8506 SF 0.20 AC

LOT 60 8506 SF 0.20 AC

LOT 61 8506 SF 0.20 AC

LOT 62 8506 SF 0.20 AC

LOT 63 8506 SF 0.20 AC

LOT 64 8506 SF 0.20 AC

CURVE TABLE

CURVE	DELTA	LENGTH	RADIUS	CHORD	CH LENGTH
C1	89.12	38.89	25.00	S69° 24' 40"W	35.08
C2	89.86	39.21	25.00	N43° 08' 39"W	35.31
C3	89.17	38.91	25.00	S46° 22' 30"W	35.10
C4	4.09	33.72	473.00	N86° 01' 59"W	33.72
C5	3.76	34.61	527.00	N86° 11' 40"W	34.60
C6	91.34	39.85	25.00	S20° 49' 08"E	35.77

NOTES:

DRAINAGE EASEMENTS ARE HEREBY GRANTED IN, ON, UNDER, OVER AND ACROSS COMMON GROUND A, B, C & D IN THEIR ENTIRETY.
A 30' LANDSCAPE EASEMENT IS HEREBY GRANTED IN, ON, UNDER, OVER AND ACROSS COMMON GROUND A IN ITS ENTIRETY.

BENCHMARK:

THE BASIS OF ELEVATIONS HEREON IS NAVD 88. IRON ROD W/ALUMINUM CAP SET IN THE NORTHWEST CORNER OF SITE - SEE DRAWING FOR LOCATION.

ELEVATION = 556.90'

SITE DATA:

NUMBER OF LOTS: 54 (INCLUDES 5 COMMON GROUND LOTS)
MINIMUM LOT SIZE: 8,000 S.F.
EXISTING ZONING: A-AGRICULTURAL DISTRICT
PROPOSED ZONING: O'FALLON, SR-2
SCHOOL DISTRICTS:
- ELEMENTARY: O'FALLON DISTRICT #90
- HIGH SCHOOL: O'FALLON HS #203

AREA SCHEDULE:

GROSS: 338,213 S.F. OR 7.76 ACRES (MORE OR LESS)
STREETS: 58,318 S.F. OR 1.34 ACRES (MORE OR LESS)
LOTS: 205,645 S.F. OR 4.72 ACRES (MORE OR LESS)
COMMON GROUND: 74,250 S.F. OR 1.70 ACRES (MORE OR LESS)

OWNER/SUBDIVIDER:

FULFORD HOMES LLC
1116 HARTMAN LN SUITE B
SHILOH, IL 62221
PHONE: 618.632.5779

PLANNER/ENGINEER

DAVID M DILLON, PE
WOOLPERT, INC.
343 FOUNTAINS PARKWAY, SUITE 100
FAIRVIEW HEIGHTS, IL 62208
PHONE: 618.632.7004

LAND SURVEYOR

STEPHEN R. KREGER, PLS
WOOLPERT, INC.
1815 SOUTH MEYERS ROAD, SUITE 120
OAKBROOK TERRACE, IL 60181
PHONE: 630.424.9080

LOT SUITABILITY

LOT	TYPE	MINIMUM LSE
1	SD	555.5
2	SD	556.5
3	SD	557.5
4	SD	557.5
5	SD	555.5
6	SD	553.0
7	SD	551.0
8	SD	549.0
34	WO	547.0
35	WO	543.5
36	WO	543.5
37	WO	543.5
38	WO	543.5
39	WO	543.5
40	LO	544.5
41	LO	546.0
42	LO	548.5
43	SD	550.0
44	WO	552.5
45	WO	552.0
46	WO	552.0
47	WO	552.0
48	WO	553.5

WO=WALK OUT BASEMENT
LO=LOOK OUT EGRESS WINDOW
SD=STANDARD TOP OF FDN WINDOW
LSE=LOW SILL/OPENING ELEVATION

REVISION	DATE	No.	PROJECT No.	DATE	SCALE	DES.	DR.	CKD.
			75597	03/10/16	AS SHOWN	SRK	JMA	PTK/SRK

WOOLPERT, INC.
1815 South Meyers Road,
Suite 120
Oakbrook Terrace, IL 60181
630.424.9080
FAX: 630.495.3731

WOOLPERT
DESIGN (LOCAL AND INTERNATIONAL)

PARKVIEW MEADOWS PHASE 1
A PART OF THE NORTHWEST QUARTER OF SECTION 30,
TOWNSHIP 2 NORTH, RANGE 7 WEST OF THE
3RD PRINCIPAL MERIDIAN, ST. CLAIR COUNTY, ILLINOIS.

SUBDIVISION PLAT

SHEET NO. 1 of 2

OWNER'S AND SCHOOL DISTRICT CERTIFICATE

STATE OF ILLINOIS)
COUNTY OF) SS.

THIS IS TO CERTIFY THAT THE UNDERSIGNED IS THE OWNER OF THE LAND DESCRIBED IN THE ATTACHED PLAT AND HAS CAUSED THE SAME TO BE SURVEYED AND SUBDIVIDED, AS INDICATED THEREON, FOR THE USES AND PURPOSES THEREIN SET FORTH, AND DOES HEREBY ACKNOWLEDGE AND ADOPT THE SAME UNDER THE STYLE AND TITLE THEREON INDICTED.

ALSO, THIS IS TO CERTIFY THAT THE PROPERTY BEING SUBDIVIDED AFORESAID AND, TO THE BEST OF OWNER'S KNOWLEDGE AND BELIEF, SAID SUBDIVISION LIES ENTIRELY WITHIN THE LIMITS OF ELEMENTARY SCHOOL DISTRICT O'FALLON DISTRICT #90 AND HIGH SCHOOL DISTRICT O'FALLON HS #203.

DATED THIS DAY OF A.D., 20

FULFORD HOMES LLC

BY: SIGNATURE ATTEST: SIGNATURE

TITLE TITLE

NOTARY CERTIFICATE

STATE OF ILLINOIS)
COUNTY OF) SS.

I, A NOTARY PUBLIC IN AND FOR SAID COUNTY, IN

THE STATE AFORESAID, DO HEREBY CERTIFY THAT AND PERSONALLY KNOWN TO ME TO BE THE SAME PERSON(S) WHOSE NAME(S) IS(ARE) SUBSCRIBED TO THE FOREGOING CERTIFICATE, APPEARED BEFORE ME THIS DAY IN PERSON AND ACKNOWLEDGED THE EXECUTION OF THE ANNEXED PLAT AS THEIR(HIS/HER) OWN FREE AND VOLUNTARY ACT(S), FOR THE USES AND PURPOSES THEREIN SET FORTH.

GIVEN UNDER MY HAND AND NOTARIAL SEAL

THIS DAY OF 20

NOTARY PUBLIC

MORTGAGEE CONSENT CERTIFICATE

STATE OF ILLINOIS)
COUNTY OF) SS.

THE UNDERSIGNED, AS MORTGAGEE, UNDER THE PROVISIONS OF A CERTAIN MORTGAGE DATED A.D., 20 AND RECORDED IN THE RECORDER OF DEEDS OFFICE OF COUNTY, ILLINOIS ON THE DAY OF A.D., 20 AS DOCUMENT NO. HEREBY CONSENTS TO AND APPROVES THE ANNEXED PLAT DEPICTED HEREON.

DATED THIS DAY OF A.D. 20

MORTGAGEE NAME:

BY: ATTEST:

ITS: ITS: SIGNATURE

NOTARY CERTIFICATE

STATE OF ILLINOIS)
COUNTY OF) SS.

I, A NOTARY PUBLIC IN AND FOR SAID COUNTY, IN

THE STATE AFORESAID, DO HEREBY CERTIFY THAT AND PERSONALLY KNOWN TO ME TO BE THE SAME PERSON(S) WHOSE NAME(S) IS(ARE) SUBSCRIBED TO THE FOREGOING CERTIFICATE, APPEARED BEFORE ME THIS DAY IN PERSON AND ACKNOWLEDGED THE EXECUTION OF THE ANNEXED PLAT AS THEIR(HIS/HER) OWN FREE AND VOLUNTARY ACT(S), FOR THE USES AND PURPOSES THEREIN SET FORTH.

GIVEN UNDER MY HAND AND NOTARIAL SEAL

THIS DAY OF 20

NOTARY PUBLIC

FINAL PLAT OF PARKVIEW MEADOWS PHASE 1

A PART OF THE NORTHWEST QUARTER OF SECTION 30, TOWNSHIP 2 NORTH, RANGE 7 WEST OF THE 3RD PRINCIPAL MERIDIAN, ST. CLAIR COUNTY, ILLINOIS.

PROPERTY DESCRIPTION:

PARCEL 1: THAT PART OF LOT 21 IN THE NW 1/4 OF SECTION 30, T2N, R7W 3RD P.M., ST CLAIR COUNTY, ILLINOIS, DESCRIBED AS FOLLOWS: COMMENCING AT THE INTERSECTION OF THE NORTH LINE OF LOT 13 WITH THE CENTERLINE OF THE PUBLIC ROAD; THENCE IN AN EASTERLY DIRECTION; ALONG THE NORTH LINE OF LOT 13, TO THE NORTHEAST CORNER OF LOT 13; THENCE IN A NORTHERLY DIRECTION, ALONG THE WEST LINE OF LOT 17A AND ITS EXTENSION, A DISTANCE OF 600.00 FEET TO A POINT; THENCE IN A NORTHWESTERLY DIRECTION TO A POINT IN THE CENTERLINE OF THE PUBLIC ROAD, SAID POINT BEING 660.0 FEET NORTH OF THE NORTH LINE OF LOT 13, MEASURED AT RIGHT ANGLES; THENCE IN SOUTHWESTERLY AND SOUTHERLY DIRECTION, ALONG THE CENTERLINE OF THE PUBLIC ROAD TO THE POINT OF BEGINNING.

EXCEPTING THEREFROM THAT PART OF THE ABOVE DESCRIBED TRACT OF LAND LYING WITHIN THE RIGHT OF WAY OF SAID PUBLIC ROAD.

ALSO EXCEPTING THEREFROM THE FOLLOWING LEGAL DESCRIPTION;

PART OF LOT 13 AND PART OF LOT 21 OF THE NW 1/4 OF SECTION 30, IN T2N, R7W 3RD P.M., ST. CLAIR COUNTY, ILLINOIS, AND BEING MORE PARTICULARLY DESCRIBED AS FOLLOWS, TO WIT:

COMMENCING AT THE SOUTHWEST CORNER OF THE NW 1/4 OF SAID SECTION 30, RUNNING THENCE NORTH 02°35'48" EAST ALONG THE WEST LINE OF SAID NW 1/4 OF SECTION 30, A DISTANCE OF 948.35 FEET TO A POINT; RUNNING THENCE SOUTH 87°24'12" EAST, A DISTANCE OF 26.08 FEET TO A POINT ON THE EAST RIGHT OF WAY LINE OF "OBERNUEFFEMANN ROAD", SAID POINT BEING THE POINT OF BEGINNING OF THE TRACT HEREIN DESCRIBED; RUNNING THENCE SOUTH 86°33'38" EAST, A DISTANCE OF 433.98 FEET TO A POINT; RUNNING THENCE NORTH 02°34'44" EAST, A DISTANCE OF 250.79 FEET TO A POINT; RUNNING THENCE NORTH 86°33'38" WEST, A DISTANCE OF 426.39 FEET TO A POINT ON THE EAST RIGHT OF WAY LINE OF SAID "OBERNUEFFEMANN ROAD", SAID RIGHT OF WAY LINE BEING ON A CURVE TO THE LEFT HAVING A RADIUS OF 612.27 FEET, RUNNING THENCE SOUTHERLY ALONG SAID CURVE, THE CHORD OF WHICH BEARS SOUTH 7°15'09" WEST, A DISTANCE OF 121.61 FEET TO A POINT; CONTINUING THENCE SOUTH 1°33'10" WEST, A DISTANCE OF 129.49 FEET TO THE POINT OF BEGINNING AND CONTAINS 2.5 ACRES, MORE OR LESS.

ALSO EXCEPTING THEREFROM THE FOLLOWING LEGAL DESCRIPTION;

THAT PART OF LOT 21 IN THE NW 1/4 OF SECTION 30, T2N, R7W 3RD P.M., ST CLAIR COUNTY, ILLINOIS, DESCRIBED AS FOLLOWS: COMMENCING AT THE INTERSECTION OF THE NORTH LINE OF LOT 13 WITH THE CENTERLINE OF THE PUBLIC ROAD; THENCE IN AN EASTERLY DIRECTION, ALONG THE NORTH LINE OF LOT 13, A DISTANCE OF 746.31 FEET TO A POINT 46.80 FEET WESTERLY OF AN IRON REBAR FOUND AT THE NORTHEAST CORNER OF LOT 4 IN BROOKSIDE ESTATES PER THE PLAT THEREOF RECORDED AUGUST 19, 1996 IN THE ST. CLAIR COUNTY RECORDER'S OFFICE PER BOOK 94, PAGE 93, SAID POINT BEING THE POINT OF BEGINNING OF THIS DESCRIPTION; THENCE NORTH 01 DEGREE 47 MINUTES 16 SECONDS EAST, A DISTANCE OF 452.52 FEET; THENCE NORTH 02 DEGREES 51 MINUTES 58 SECONDS EAST, A DISTANCE OF 54.07 FEET; THENCE NORTH 05 DEGREES 41 MINUTES 14 SECONDS EAST, A DISTANCE OF 126.46 FEET TO THE SOUTH LINE OF PLAT NO. 1 FIFTH ADDITION TO WESTBROOK RECORDED MAY 1, 1970 IN THE ST. CLAIR COUNTY RECORDER'S OFFICE PER BOOK 63, PAGE 127, SAID POINT BEING 107.35 FEET EASTERLY OF AN IRON REBAR FOUND AT THE SOUTHWEST CORNER OF LOT 30 IN SAID PLAT NO. 1 FIFTH ADDITION TO WESTBROOK; THENCE SOUTH 88 DEGREES 03 MINUTES 25 SECONDS EAST, ALONG THE SOUTH LINE OF SAID PLAT NO. 1 FIFTH ADDITION TO WESTBROOK, A DISTANCE OF 681.23 FEET TO THE NORTHERLY EXTENSION OF THE WEST LINE OF SAID LOT 17A; THENCE ALONG SAID NORTHERLY EXTENSION, AND ALSO ALONG THE WEST LINE OF SAID LOT 17A, SOUTH 00 DEGREES 23 MINUTES 02 SECONDS WEST, A DISTANCE OF 599.56 FEET TO THE NORTHEAST CORNER OF SAID LOT 13, AS WITNESSED BY AN IRON REBAR FOUND 0.20 FEET SOUTH OF SAID LOCATION; THENCE SOUTH 89 DEGREES 13 MINUTES 44 SECONDS WEST, ALONG THE SOUTH LINE OF SAID LOT 21, A DISTANCE OF 706.24 FEET TO THE POINT OF BEGINNING. THE BEARINGS IN THIS DESCRIPTION ARE BASED UPON THE ILLINOIS STATE PLANE COORDINATE SYSTEM WEST ZONE (NAD83).

NOTES:

- 1. DISTANCES ARE SHOWN IN FEET AND DECIMAL PARTS THEREOF.
2. NO DIMENSION SHALL BE ASSUMED BY SCALE MEASUREMENT HEREON.
3. THE BASIS OF MEASURED BEARINGS SHOWN HEREON IS THE ILLINOIS STATE PLANE COORDINATE SYSTEM WEST ZONE; FIPS ZONE 1202; (NAD 83).
4. THIS PROPOSED SUBDIVISION WAS PREVIOUSLY ANNEXED TO THE CITY OF O'FALLON.
5. ALL EASEMENTS SHOWN HEREON ARE GRANTED FOR PUBLIC AND PRIVATE UTILITIES.
6. SUBDIVISION SHALL BE MONUMENTED PER STATE STATUTES WITH 5/8"x24" IRON RODS.
7. THE MINIMUM FIRST FLOOR OF EACH BUILDING OR STRUCTURE LOCATED ADJACENT TO OR IN THE VICINITY OF A STORM SEWER PIPE OR APPURTENANT STRUCTURE SHALL BE ESTABLISHED TO ACCOMMODATE THE HEADWATER THAT MAY BE DEVELOPED DURING THE ONE-HUNDRED (100) YEAR STORM EVENT.
8. ALL EASEMENTS SHALL BE MAINTAINED BY THE LOT OWNER OR FULFORD HOMES, L.L.C., AN ILLINOIS LIMITED LIABILITY COMPANY.
9. NO FENCES, SHEDS, WOOD PILES, ETC. TO BE CONSTRUCTED WITHIN ANY DRAINAGE EASEMENTS.
10. THE STREET RIGHTS-OF-WAY SHOWN WITHIN THIS PLAT ARE HEREBY GRANTED TO THE CITY OF O'FALLON.
11. THIS SURVEY DOES NOT CONSTITUTE A TITLE SEARCH BY WOOLPERT, INC. ALL INFORMATION REGARDING RECORD EASEMENTS AND OTHER DOCUMENTS THAT MAY AFFECT THE QUALITY OF THE TITLE TO THE SUBJECT TRACT IS BASED UPON STEWART TITLE GUARANTY COMPANY COMMITMENT FOR TITLE INSURANCE, FILE NO. 153633BMT WITH AN EFFECTIVE DATE OF MAY 1, 2015.
12. THE ERROR OF CLOSURE OF THIS PLAT IS NOT MORE THAN ONE (1) FOOT IN FIVE THOUSAND (5,000) FEET.

ST. CLAIR COUNTY RECORDER OF DEEDS CERTIFICATE

STATE OF ILLINOIS)
COUNTY OF ST. CLAIR) SS.

THIS INSTRUMENT NO. WAS FILED FOR RECORD IN THE OFFICE OF ST. CLAIR COUNTY RECORDER OF DEEDS ON THE DAY OF A.D., 20 AT O'CLOCK M.,

AND RECORDED IN BOOK OF PLATS ON PAGE AS

DOCUMENT NO.

RECORDER OF DEEDS

EXISTING PARCEL INDEX NUMBER: 04-30.0-101-046

THIS PLAT HAS BEEN SUBMITTED FOR RECORDING BY AND RETURN TO: NAME: ADDRESS:

ENGINEER'S CERTIFICATE

THIS IS TO CERTIFY THAT ALL REQUIRED AND APPLICABLE AGENCIES WERE PROPERLY NOTIFIED AND APPROVED OF THE PROJECT, AND THESE AGENCY NOTIFICATIONS SHALL INCLUDE: ILLINOIS HISTORIC PRESERVATION AGENCY (IHPA); ILLINOIS DEPARTMENT OF NATURAL RESOURCES (IDNR - ENDANGERED SPECIES); ILLINOIS DEPARTMENT OF NATURAL RESOURCES (IDNR - STREAM HYDRAULICS); NATURAL RESOURCE CONSERVATION SERVICE (NRCS); U.S. ARMY CORPS OF ENGINEERS (USACE - CLEAN WATER ACT - STREAM HYDRAULICS); ILLINOIS ENVIRONMENTAL PROTECTION AGENCY (IEPA - STORM WATER PERMIT); ST. CLAIR COUNTY DEPARTMENT OF ROADS AND BRIDGES (ENTRANCE PERMIT); ILLINOIS DEPARTMENT OF TRANSPORTATION DIVISION OF HIGHWAYS (IDOT - ENTRANCE PERMIT); U.S. DEPARTMENT OF AGRICULTURE (USDA - PRIME FARM LAND).

WOOLPERT, INC.

DAVID M. DILLOW PROFESSIONAL ENGINEER 062-047964 STATE OF ILLINOIS LICENSE EXPIRES NOVEMBER 30, 2017

WOOLPERT, INC.

ILLINOIS PROFESSIONAL DESIGN FIRM REGISTRATION NUMBER 184-001393

SURVEYOR'S CERTIFICATE

THIS IS TO CERTIFY THAT I, STEPHEN R. KREGER, ILLINOIS PROFESSIONAL LAND SURVEYOR NO. #35-002985, AT THE REQUEST OF THE OWNER(S) THEREOF, HAVE SURVEYED, SUBDIVIDED AND PLATTED THE FOLLOWING DESCRIBED PROPERTY:

PARCEL 1: THAT PART OF LOT 21 IN THE NW 1/4 OF SECTION 30, T2N, R7W 3RD P.M., ST CLAIR COUNTY, ILLINOIS, DESCRIBED AS FOLLOWS: COMMENCING AT THE INTERSECTION OF THE NORTH LINE OF LOT 13 WITH THE CENTERLINE OF THE PUBLIC ROAD; THENCE IN AN EASTERLY DIRECTION, ALONG THE NORTH LINE OF LOT 13, TO THE NORTHEAST CORNER OF LOT 13; THENCE IN A NORTHERLY DIRECTION, ALONG THE WEST LINE OF LOT 17A AND ITS EXTENSION, A DISTANCE OF 600.00 FEET TO A POINT; THENCE IN A NORTHWESTERLY DIRECTION TO A POINT IN THE CENTERLINE OF THE PUBLIC ROAD, SAID POINT BEING 660.0 FEET NORTH OF THE NORTH LINE OF LOT 13, MEASURED AT RIGHT ANGLES; THENCE IN SOUTHWESTERLY AND SOUTHERLY DIRECTION, ALONG THE CENTERLINE OF THE PUBLIC ROAD TO THE POINT OF BEGINNING.

EXCEPTING THEREFROM THAT PART OF THE ABOVE DESCRIBED TRACT OF LAND LYING WITHIN THE RIGHT OF WAY OF SAID PUBLIC ROAD.

ALSO EXCEPTING THEREFROM THE FOLLOWING LEGAL DESCRIPTION;

PART OF LOT 13 AND PART OF LOT 21 OF THE NW 1/4 OF SECTION 30, IN T2N, R7W 3RD P.M., ST. CLAIR COUNTY, ILLINOIS, AND BEING MORE PARTICULARLY DESCRIBED AS FOLLOWS, TO WIT:

COMMENCING AT THE SOUTHWEST CORNER OF THE NW 1/4 OF SAID SECTION 30, RUNNING THENCE NORTH 02°35'48" EAST ALONG THE WEST LINE OF SAID NW 1/4 OF SECTION 30, A DISTANCE OF 948.35 FEET TO A POINT; RUNNING THENCE SOUTH 87°24'12" EAST, A DISTANCE OF 26.08 FEET TO A POINT ON THE EAST RIGHT OF WAY LINE OF "OBERNUEFFEMANN ROAD", SAID POINT BEING THE POINT OF BEGINNING OF THE TRACT HEREIN DESCRIBED; RUNNING THENCE SOUTH 86°33'38" EAST, A DISTANCE OF 433.98 FEET TO A POINT; RUNNING THENCE NORTH 02°34'44" EAST, A DISTANCE OF 250.79 FEET TO A POINT; RUNNING THENCE NORTH 86°33'38" WEST, A DISTANCE OF 426.39 FEET TO A POINT ON THE EAST RIGHT OF WAY LINE OF SAID "OBERNUEFFEMANN ROAD", SAID RIGHT OF WAY LINE BEING ON A CURVE TO THE LEFT HAVING A RADIUS OF 612.27 FEET; RUNNING THENCE SOUTHERLY ALONG SAID CURVE, THE CHORD OF WHICH BEARS SOUTH 7°15'09" WEST, A DISTANCE OF 121.61 FEET TO A POINT; CONTINUING THENCE SOUTH 1°33'10" WEST, A DISTANCE OF 129.49 FEET TO THE POINT OF BEGINNING AND CONTAINS 2.5 ACRES, MORE OR LESS.

ALSO EXCEPTING THEREFROM THE FOLLOWING LEGAL DESCRIPTION;

THAT PART OF LOT 21 IN THE NW 1/4 OF SECTION 30, T2N, R7W 3RD P.M., ST CLAIR COUNTY, ILLINOIS, DESCRIBED AS FOLLOWS: COMMENCING AT THE INTERSECTION OF THE NORTH LINE OF LOT 13 WITH THE CENTERLINE OF THE PUBLIC ROAD; THENCE IN AN EASTERLY DIRECTION, ALONG THE NORTH LINE OF LOT 13, A DISTANCE OF 746.31 FEET TO A POINT 46.80 FEET WESTERLY OF AN IRON REBAR FOUND AT THE NORTHEAST CORNER OF LOT 4 IN BROOKSIDE ESTATES PER THE PLAT THEREOF RECORDED AUGUST 19, 1996 IN THE ST. CLAIR COUNTY RECORDER'S OFFICE PER BOOK 94, PAGE 93, SAID POINT BEING THE POINT OF BEGINNING OF THIS DESCRIPTION; THENCE NORTH 01 DEGREE 47 MINUTES 16 SECONDS EAST, A DISTANCE OF 452.52 FEET; THENCE NORTH 02 DEGREES 51 MINUTES 58 SECONDS EAST, A DISTANCE OF 54.07 FEET; THENCE NORTH 05 DEGREES 41 MINUTES 14 SECONDS EAST, A DISTANCE OF 126.46 FEET TO THE SOUTH LINE OF PLAT NO. 1 FIFTH ADDITION TO WESTBROOK RECORDED MAY 1, 1970 IN THE ST. CLAIR COUNTY RECORDER'S OFFICE PER BOOK 63, PAGE 127, SAID POINT BEING 107.35 FEET EASTERLY OF AN IRON REBAR FOUND AT THE SOUTHWEST CORNER OF LOT 30 IN SAID PLAT NO. 1 FIFTH ADDITION TO WESTBROOK; THENCE SOUTH 88 DEGREES 03 MINUTES 25 SECONDS EAST, ALONG THE SOUTH LINE OF SAID PLAT NO. 1 FIFTH ADDITION TO WESTBROOK, A DISTANCE OF 681.23 FEET TO THE NORTHERLY EXTENSION OF THE WEST LINE OF SAID LOT 17A; THENCE ALONG SAID NORTHERLY EXTENSION, AND ALSO ALONG THE WEST LINE OF SAID LOT 17A, SOUTH 00 DEGREES 23 MINUTES 02 SECONDS WEST, A DISTANCE OF 599.56 FEET TO THE NORTHEAST CORNER OF SAID LOT 13, AS WITNESSED BY AN IRON REBAR FOUND 0.20 FEET SOUTH OF SAID LOCATION; THENCE SOUTH 89 DEGREES 13 MINUTES 44 SECONDS WEST, ALONG THE SOUTH LINE OF SAID LOT 21, A DISTANCE OF 706.24 FEET TO THE POINT OF BEGINNING. THE BEARINGS IN THIS DESCRIPTION ARE BASED UPON THE ILLINOIS STATE PLANE COORDINATE SYSTEM WEST ZONE (NAD83).

I FURTHER HEREBY CERTIFY THAT THE FOREGOING PROPERTY FALLS WITHIN THE CORPORATE LIMITS OF THE CITY OF O'FALLON, WHICH HAS ADOPTED A CITY PLAN AND IS EXERCISING THE SPECIAL POWERS AUTHORIZED BY DIVISION 12 OF ARTICLE 11 OF THE ILLINOIS MUNICIPAL CODE. IN ACCORDANCE WITH S.B. 908-P.A. 85-267, I FURTHER CERTIFY THAT NO PART OF THE PROPERTY COVERED BY THIS SUBDIVISION IS LOCATED WITHIN A SPECIAL FLOOD HAZARD AREA AS IDENTIFIED BY THE FEDERAL EMERGENCY MANAGEMENT AGENCY. AS SHOWN ON FIRM MAP, COMMUNITY PANEL NO. 171630C0206D, DATED NOVEMBER 5, 2003.

I FURTHER HEREBY CERTIFY THAT ALL SUBDIVISION MONUMENTS WILL BE SET AND I HAVE DESCRIBED THEM ON THIS FINAL PLAT AS REQUIRED BY THE PLAT ACT (765 ILCS 205/), THE EXTERIOR MONUMENTS HAVE BEEN SET AND THE INTERIOR MONUMENTS WILL BE SET WITHIN 12 MONTHS OF THE RECORDING OF THIS PLAT AS PROVIDED BY STATE STATUTE.

THIS SURVEY MEETS THE CURRENT "ILLINOIS MINIMUM STANDARDS FOR PROPERTY BOUNDARY SURVEYS".

GIVEN UNDER MY HAND AND SEAL THIS DAY OF 20, A.D.

WOOLPERT, INC.

STEPHEN R. KREGER PROFESSIONAL LAND SURVEYOR #35-002985 STATE OF ILLINOIS LICENSE EXPIRES NOVEMBER 30, 2016

WOOLPERT, INC. ILLINOIS PROFESSIONAL DESIGN FIRM REGISTRATION NUMBER 184-001393



REVISION

DATE

No.

PROJECT No: 75597 DATE 03/10/16 SCALE AS SHOWN DES. SRK DR. JMA CKD. PTK/SRK

WOOLPERT, INC. 1815 South Meyers Road, Suite 120 Oakbrook Terrace, IL 60181 630.424.9080 FAX: 630.495.3731

PARKVIEW MEADOWS PHASE 1 A PART OF THE NORTHWEST QUARTER OF SECTION 30, TOWNSHIP 2 NORTH, RANGE 7 WEST OF THE 3RD PRINCIPAL MERIDIAN, ST. CLAIR COUNTY, ILLINOIS.

SUBDIVISION PLAT

SHEET NO.

G:\CS\Projects\Various\75597 - Plat Phase 1.dwg - Plotted By: andersonj - Plotted: Apr 27, 2016 - 2:29pm



MEMORANDUM

TO: Community Development Committee
FROM: Justin Randall, Senior City Planner
THROUGH: Ted Shekell, Director of Community Development
DATE: June 13, 2016
SUBJECT: P2016-03: Lincoln Park Villas - MR-2 Zoning Amendment & Planned Use

Recommendation

The Planning Commission held a public hearing on the above referenced application at their May 24, 2016 meeting. At the Public Hearing, concerns were over drainage, pedestrian safety, setbacks of the buildings along the Woodgate subdivision and rental cost for the development. The Commission voted 5-ayes and 1-nay to approve the requested Zoning Amendment and Planned Use for Parkview Meadows, subject to the conditions recommended by staff and an additional condition that the buildings along the Woodgate subdivision be setback 20 feet from the property line.

Project Background and Summary

- Property located on the west side of Lincoln Road, just south of GCS Credit Union and O'Fallon Public Library.
- Senior Living Development consisting of 6.98 acres.
- 13 proposed buildings ranging from 4 units to 8 units.
- Community Building, with a fitness area, gathering space and offices for the development and special outside services.
- Zoned B-1(P) – Planned Community Business District.
- Requested to be rezoned to MR-2(P), Planned Multi-Family Residential Dwelling District.
- Connecting Civic Plaza to the drive just south of GCS Credit Union.
- The gross density is 11.3 units per acre.
- The developer will be tying into the City of O'Fallon water and sanitary sewer services.
- Planned Use is also approving preliminary plat, location of street and new utilities.
- A final plat will need to be filed prior to final approval.

The applicant, RCH Development, Inc., is proposing to create a 72 unit multi-family community for seniors 55 years of age or old, including a clubhouse facility with fitness equipment, open gathering areas, and offices. The developer has stated the property will be deed/plat restricted to limit the age of renters to 55 year of age and older. The property is located on the west side of Lincoln Avenue, just south of GCS Credit Union and O'Fallon Public Library. The 72 unit senior living community has a calculated density of 11.3 units / acre and provides 162 parking spaces for the development. There is a proposed detention pond in the northwest corner of the development, which will tie into the detention basins behind the library and an existing detention pond that will serve a portion of the development and the GCS Credit Union site.

The development will connect the existing Civic Plaza that ends at the library parking lot to the street providing access to GCS Credit Union. The proposed extension of Civic Plaza will be consistent with the existing Civic Plaza, maintaining the 60-foot right-of-way and 30-foot of pavement face of curb to face of curb. The development will only have access

Community Development Department

255 South Lincoln Avenue O'Fallon, IL 62269 ♦ P: 618.624.4500 x 4 ♦ F:618.624.4534

to Civic Plaza. Civic Plaza will have two connections to Lincoln Avenue. There are no other connections to the south or west due to existing development. Sidewalks have been incorporated into the preliminary site plan on both sides of Civic Plaza, along Lincoln Avenue and throughout the development.

The developer will be tying into the City of O'Fallon sanitary sewer and water system. Electric and gas services are available to the site and owned by Ameren IP. Telephone and internet service is available through AT&T and cable and internet is available through Charter.

The property is currently zoned B-1(P), Planned Community Business District and the developer is requesting the property to be rezoned to MR-2, Multi-Family Residential Dwelling District. Although multi-family is allowed in the B-1 district, MR-2 is the more appropriate zoning district due to the residential developments to the east and west of the site. The development will have a park land fee of \$510 per unit. Additionally, the extension of Civic Drive, a public street, will create two lots for the development. The Planned Use is approving two lots, the location of the street/right-of-way width and utility extensions. This project only functions if all buildings and lots stay under one common ownership, which can be accomplished with a note on the final plat. Since the development will be extending a city street and public utilities, there will be a need for subdivision improvement plans and a final plat approved by the City Council.

Please see the attached Plan Commission Project Report for more detailed information on the proposal.

Staff Recommendation

Staff recommends approval of Lincoln Park Villas with the following conditions:

1. There will be a park land dedication requirement of 0.72 acre, with the requirement being fulfilled through a fee in lieu of land in the amount of \$36,720, \$510.00 per unit.
2. A revised landscaping plan is required to including street trees and fencing.
3. A final plat is required with a note restricting the limit the age of the renters to 55 or older
4. A final plat is required with a note restricting the sale of individual lots and buildings.
5. The lots along the Woodgate subdivision are required to be setback 20 feet from the property line.

Attachments:

1. Report to Plan Commission
2. Ordinance approving the Lincoln Park Villa Development



PROJECT REPORT

TO: Planning Commission
FROM: Justin Randall, Senior City Planner
THRU: Ted Shekell, Community Development Director
DATE: May 24, 2016
SUBJECT: P2016-03: Lincoln Park Villas – MR-2 Zoning Amendment & Planned Use

Applicant: Chad Hartle
RCH Development, Inc.
2201 Walton Drive
Jackson, MO 63755

Owner: GCS Federal Credit Union
3970 Maryville Road
Granite City, IL 62040

Submitted: April 18, 2016

Project Summary

- Property located on the west side of Lincoln Road, just south of GCS Credit Union and O'Fallon Public Library.
- Senior Living Development consisting of 6.98 acres.
- 13 proposed buildings ranging from 4 units to 8 units.
- Community Building, with a fitness area, gathering space and offices for the development and special outside services.
- Zoned B-1(P) – Planned Community Business District.
- Requested to be rezoned to MR-2(P), Planned Multi-Family Residential Dwelling District.
- Connecting Civic Plaza to the drive just south of GCS Credit Union.
- The gross density is 11.3 units per acre.
- The developer will be tying into the City of O'Fallon water and sanitary sewer services.
- Planned Use is also approving preliminary plat, location of street and new utilities.
- A final plat will need to be filed prior to final approval.

Background & Executive Summary

The applicant, RCH Development, Inc., is proposing to create a 72 unit multi-family community for seniors 55 years of age or old, including a clubhouse facility with fitness equipment, open gathering areas, and offices. The developer has stated the property will be deed/plat restricted to limit the age of renters to 55 year of age and older. The property is located on the west side of Lincoln Avenue, just south of GCS Credit Union and O'Fallon Public Library. The 72 unit senior living community has a calculated density of 11.3 units / acre and provides 162 parking spaces for the

Community Development Department
255 South Lincoln Avenue O'Fallon, IL 62269 ♦ P: 618.624.4500 x 4 ♦ F: 618.624.4534

development. There is a proposed detention pond in the northwest corner of the development, which will tie into the detention basins behind the library and an existing detention pond that will serve a portion of the development and the GCS Credit Union site.

The development will connect the existing Civic Plaza that ends at the library parking lot to the street providing access to GCS Credit Union. The proposed extension of Civic Plaza will be consistent with the existing Civic Plaza, maintaining the 60-foot right-of-way and 30-foot of pavement face of curb to face of curb. The development will only have access to Civic Plaza. Civic Plaza will have two connections to Lincoln Avenue. There are no other connections to the south or west due to existing development. Sidewalks have been incorporated into the preliminary site plan on both sides of Civic Plaza, along Lincoln Avenue and throughout the development.

The developer will be tying into the City of O'Fallon sanitary sewer and water system. Electric and gas services are available to the site and owned by Ameren IP. Telephone and internet service is available through AT&T and cable and internet is available through Charter.

The property is currently zoned B-1(P), Planned Community Business District and the developer is requesting the property to be rezoned to MR-2, Multi-Family Residential Dwelling District. Although multi-family is allowed in the B-1 district, MR-2 is the more appropriate zoning district due to the residential developments to the east and west of the site. The development will have a park land fee of \$510 per unit. Additionally, the extension of Civic Drive, a public street, will create two lots for the development. The Planned Use is approving two lots, the location of the street/right-of-way width and utility extensions. This project only functions if all buildings and lots stay under one common ownership, which can be accomplished with a note on the final plat. Since the development will be extending a city street and public utilities, there will be a need for subdivision improvement plans and a final plat approved by the City Council.

Existing Conditions

Surrounding Zoning:

North: B-1(P) & SR-1
East: SR-2
South: B-1 & B-1(P)
West: MR-2/PUD

Surrounding Land Use:

North: GCS Credit Union, O'Fallon Public Library
US Post Office.
East: Single-family residential development of
Southview Gardens subdivision.
South: Multiple office buildings along Springfield
Court.
West: Multi-family residential development of
Woodgate subdivision.

The site is currently used for agriculture purposes. The site is generally flat, with a slight grade from Lincoln Avenue to the northwest corner. The site does not have any floodplain, nor any areas identified as a riparian area. There are no known environmental hazards on the site.

Applicable Ordinances, Documents and Reports

O'Fallon Comprehensive Plan:

The O'Fallon Comprehensive Plan Future Land Use Map depicts the subject property as Office. Within the Office District, Nursing Homes are identified as an allowed use. While this is not a nursing home, the development of senior housing community is comparable and consistent with the Office designation.

Code of Ordinances:

The proposed subdivision is subject to Chapter 154 (Subdivision) Chapter 155 (Development Manual) and Chapter 158 (Zoning) of the Code of Ordinance and must meet the Area-Bulk requirements for lot dimensions. The property is also subject to the MR-2, Multi-Family Residence Dwelling District requirements.

Public Notice:

Public Notice of this project has been fulfilled in accordance with Section 158.255 and 158.256 of the City of O'Fallon Zoning Regulations. More specifically, the applicant has notified property owners within 250 feet of the subject property via certified mail of the filing of the zoning amendment. Additionally, the City has notified property owners within 250 feet of the subject parcel of the public hearing at least 15 days prior to the hearing and published notice of the public hearing in a local newspaper at least 15 days in advance. Proof of notification is on file with the City's Community Development Department.

Discussion Points/Issues

General Discussion:

The Lincoln Park Villas senior community development consists of 6.98 acres with 72 units in a requested MR-2 zoning district. The developer has stated the property will be deed/plat restricted to limit the age of renters to 55 year of age and older. The proposed development will have an overall density of 11.3 units per acre, well under the 16 units allowed under the MR-2 zoning district. Additionally, the proposed development meets all the other area/bulk requirements of the MR-2 district. The 72 units will be built to meet the Green Building Standards to reduce utility costs and all units will include high efficiency appliances. The units will be a mixture of one and two bedrooms. The one bedroom units are approximately 750 square feet and the two bedrooms are approximately 865 square feet. In addition to the 72 units, a clubhouse facility will be constructed with a fitness area, gathering space and offices. The intent is for third party services be able to use an office, such as nurses, tax return prepares, educational providers and other services to be provided for the residences. This project only functions if all buildings and lots stay under one common ownership, which can be accomplished with a note on the final plat.

Access, Circulation and Parking:

The proposal will extend the existing Civic Plaza (a public street), which provides access to the library and access for GCS Credit Union. The completed Civic Plaza will create two points of access for the development (and the library) to Lincoln Avenue. The proposal will have four points of access onto Civic Plaza. Civic Plaza is proposed to be constructed within a 60-foot right of way and a width of 30 feet, face of curb to face of curb. This is consistent with the existing street segments of Civic Plaza from Lincoln Avenue to the library parking lot and Lincoln Avenue to the rear of the GCS Credit Union property.

Within the development, the access to the buildings is comprised of 24-foot wide drive aisles with parking spaces. The layout provides sufficient on- and off-site circulation. The site is required to provide 2 parking spaces per unit, totaling 144 parking spaces. The site is designed with 162 parking spaces to accommodate the residents and their guest. The development has provided sidewalks along both sides of Civic Plaza and sidewalks that connect all of the units to the parking lot, as well as to Civic Plaza. Additionally, sidewalks will be provided along Lincoln Avenue.

Drainage and Detention:

The site topography shows two drainage sub-basin areas for the property. Generally, the eastern portion of the site flows to the south towards an existing detention basin, designed to collect stormwater for the eastern portion of the subject property and the GCS Credit Union development. The remainder of the subject property generally drains to the northwest corner of the property, where a large detention basin is proposed. Actual detention pond sizes, grading, pipe sizes, and inlets will be engineered for the final plat phase. All drainage plans must be reviewed and approved by the Public Works Department.

Utilities:

The developer will be tying into the City of O'Fallon water system. The development will complete a loop of two 8" lines that stub at the end of the library property and the end of the GCS Credit Union Property. Within the development 8" water lines will be utilized to provide water to the units. Additionally, the developer will be utilizing the City of O'Fallon sanitary sewer system, tying the proposed development into the existing sanitary sewer main that runs through the subject property. Electric and gas services are available to the site and owned by Ameren IP. Telephone and internet service is available through AT&T and cable and internet is available through Charter.

Street Trees, Landscape Berms, and Buffers:

A preliminary landscape plan has been submitted for the parking lot areas and open spaces. The developer will be required to install street trees in the 7' wide lawn between the curb and sidewalk every 50 feet along the streets in the development. The regulations will require a vinyl fence along the eastern property line that adjoins the GCS Credit Union property. A berm along Civic Plaza and Lincoln Avenue is not required because the buildings will be oriented so the front elevations are facing the streets.

Building Elevations and Signage:

The developer has provided building elevations for the senior living facility that are consistent with other residential and multi-family developments within the city. The elevations are constructed of varying building materials, including fiber cement siding, stone veneer, brick veneer, columns and varying roof pitches. The development has proposed as many front elevations as possible to be seen from Lincoln Avenue and Civic Plaza. However Building 2 and Building 3 will have highly visible rear elevations. Building 2 adjoins the parking lot of the library and Building 3 adjoins the rear of GCS Credit Union, both will be aided by the vinyl fence required in the landscaping package.

The developer has provided an area near the intersection of Lincoln Avenue and Civic Plaza to construct a monument sign. The City and developer are in discussions to create a sign that will provide a space for the O'Fallon Public Library, however final design and sizing has not be finalized.

Open Space:

As detailed in Article 4 of Chapter 155 (Subdivisions), park lands are required to be constructed, or a fee in-lieu-of paid, whenever new residential developments are constructed. Based on the average density of 1.66 persons per apartment unit, the development's 72 units requires a total of 0.72 acre of park lands dedication. This is based on the 6 acres of park space per 1000 people. The subdivision's population estimate is 120 (72 x 1.66). A fee of \$36,720 (based on a construction cost of \$51,000 for one acre of park land) will be required for the 0.72 acre of park space, totaling \$510 per unit.

Criteria for considering General Rezoning applications:

In considering any application for rezoning, the Commission and the Governing Body may give consideration to the criteria stated below to the extent they are pertinent to the particular application. The Commission and Governing Body also may consider other factors that may be relevant to a particular application. The rezoning of the Lincoln Park Villas project appears to meet each of the following zoning criteria:

- a) the existing uses and zoning of nearby property;
- b) the extent to which property values are diminished by the particular zoning restrictions;
- c) the extent to which the destruction of property values of plaintiff promote the health, safety, morals or welfare of the public;
- d) the relative gain to the public as compared to the hardship imposed upon the individual property owner;
- e) the suitability of the subject property for the zoned purposes;
- f) the length of time the property has been vacant as zoned considered in the context of land development in the area in the vicinity of the subject property;
- g) the care that the community has taken to plan its land use development, and
- h) the community need for the proposed use.

Conclusion and Recommendation

Staff recommends approval of Lincoln Park Villas with the following conditions:

1. There will be a park land dedication requirement of 0.72 acre, with the requirement being fulfilled through a fee in lieu of land in the amount of \$36,720, \$510.00 per unit.

2. A revised landscaping plan is required to including street trees and fencing.
3. A final plat is required with a note restricting the limit the age of the renters to 55 or older
4. A final plat is required with an note restricting the sale of individual lots and buildings.

Attachments

1. Project Application & Narrative
2. Zoning Map
3. Surrounding Land Use Map
4. Site Plans
5. Building Elevations



APR 18 2016

DATE PAID

Planned Use / Re-Zoning Application

property owner: GCS Federal Credit Union
c/o Keith Bunton, President/CEO
3970 Maryville Rd, Granite City IL 62040

NAME OF PROJECT: Lincoln Park Villas

ADDRESS/GENERAL LOCATION: Rear 85% of 1159 S. Lincoln Av. O'Fallon, IL.

SUBDIVISION NAME & LOT NUMBER(S): _____

PARCEL NUMBER(S): 04310216037

PLEASE CHECK THE TYPE OF APPLICATION (PLEASE CHECK ONE):

- PLANNED USE
- RE-ZONING (STANDARD MAP AMENDMENT)

SUMMARY DATA (RESPOND TO ALL THAT APPLY):

PRESENT ZONING: B 1 (P) PROPOSED NUMBER OF BUILDINGS: 13

PROPOSED ZONING: Planned Use - M1R-2(P) PROPOSED GROSS FLOOR AREA: 68,714

PROPOSED # OF LOTS: 1 AREA IN ACRES: 6.98

PROPOSED # OF DWELLING UNITS: 72 PRESENT USE: vacant land

APPLICANT INFORMATION:

NAME: Chad Hartle (contract purchaser)

COMPANY: RCH Development, INC.

ADDRESS: 2201 Walton Dr.
Jackson, MO. 63755

PHONE: 573-576-5433

FAX: 573-243-9802

EMAIL: rent2u@sbcglobal.net

DESIGN PROFESSIONAL INFORMATION:

NAME: Tim Pruett

COMPANY: Rhutasel and Associates

ADDRESS: 4 Industrial Drive
Freeburg, IL. 62243

PHONE: 618-539-3178

FAX: 618-539-3174

EMAIL: tim.pruett@rhutasel.net

SIGNATURE OF APPLICANT

SIGNATURE OF DESIGN PROFESSIONAL

DATE RECEIVED: <u>April 18, 2016</u>	STAFF USE ONLY	PROJECT ID #: <u>P2016-03</u>
APPLICATION RECEIVED BY: <u>V. Evans</u>		STAFF ASSIGNED: <u>J. Randall</u>
APPLICATION FEE: <u>\$500.00</u>		PLAN REVIEW FEE DEPOSIT REC'D: <u>yes</u>

RCH DEVELOPMENT, INC.
2201 Walton Drive
Jackson, Mo. 63755
573-243-1463



P2016-03
narrative for
Lincoln Park
Villas

RECEIVED APR 18 2016

The proposed development is a 72 unit multifamily community for seniors 55 years of age or older that includes a clubhouse facility with fitness equipment, open seating area for resident gatherings, office and spare office for third part services such as visiting nurses, tax return preparers, educational providers and private meetings. We anticipate tying in to existing programs for seniors such as blood pressure clinics, check-ups, lunch n' learns on health topics, and general health care programs.

Each villa will be built according to the National Association of Home Builders and International Code Council National Green Building Standards and will be constructed using Universal Design concepts. The 2 bedroom units will be approximately 865 sq. ft. in size and the 1 bedroom units approximately 750 sq. ft. Both unit sizes will feature high efficiency HVAC, washers and dryers, dishwashers, garbage disposals, microwaves as well as stoves and refrigerators.

The close proximity of this site to the City Park, Public Library, Post Office, shopping and medical services makes it ideal for senior living. A facility of this type helps senior maintain their independent living status longer than they are able to do in their homes as well as provide a social atmosphere that is conducive to a healthy lifestyle.

RCH Development, INC.

Chad Hartle
President

P2016-03: Lincoln Park Villas - Zoning Map

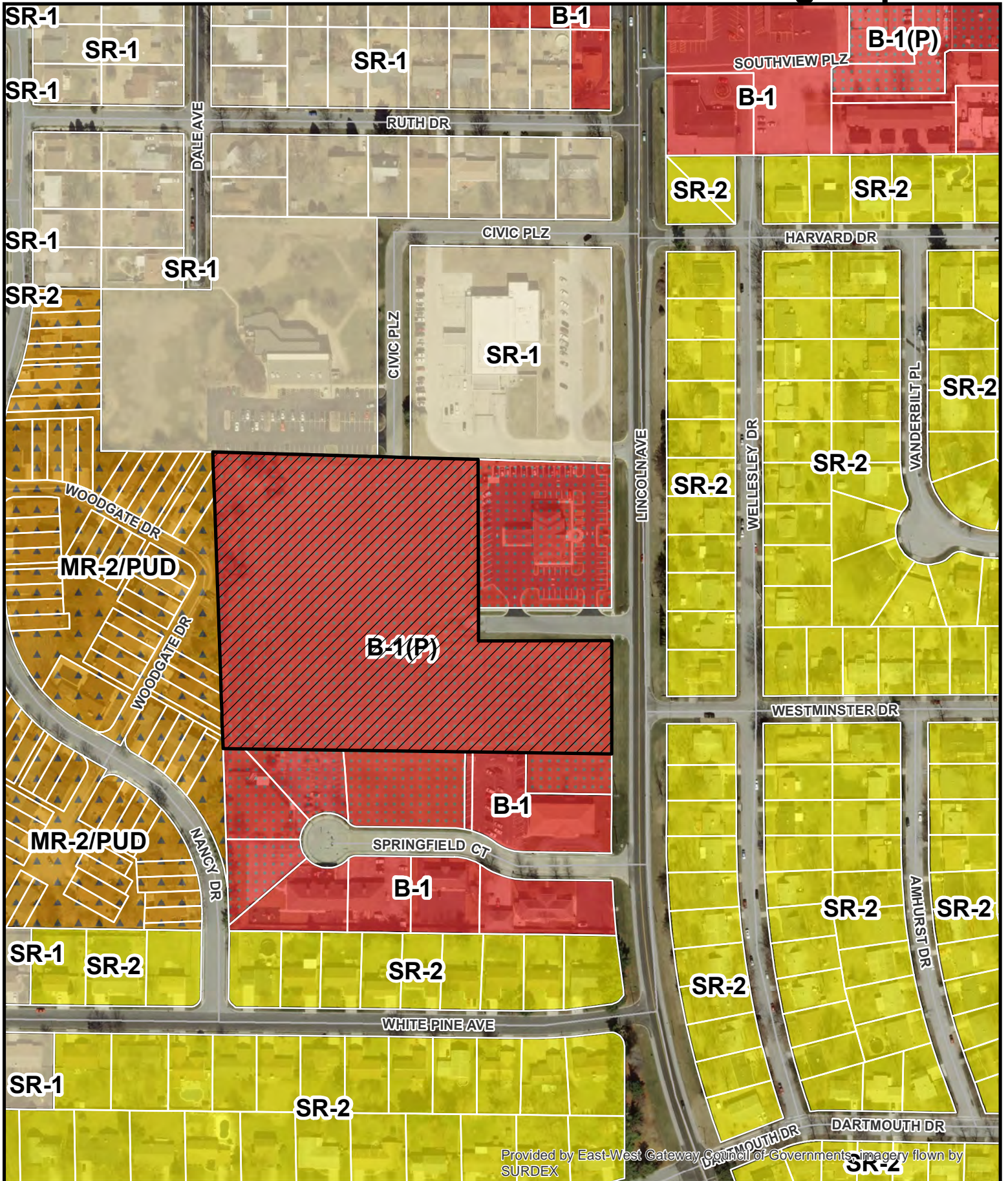

Provided by East-West Gateway Council of Governments, Imagery flown by SURDEX

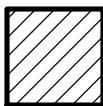

Subject Property

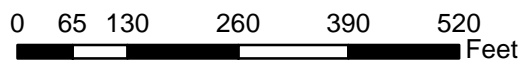

P2016-03: Lincoln Park Villas - Land Use Map



Provided by East-West Gateway Council of Governments, imagery flown by SURDEX

DARTMOUTH DR

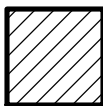

Subject Property

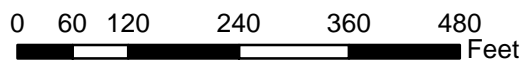

PRELIMINARY SITE PLAN

FOR

LINCOLN PARK VILLAS

RCH DEVELOPMENT, INC.

ST. CLAIR COUNTY, ILLINOIS

CITY OF O'FALLON

INDEX OF SHEETS

1. COVER SHEET
2. SITE PLAN
3. UTILITY AND GRADING PLAN
4. BUILDING SCHEDULE

OWNER

RCH DEVELOPMENT, INC.
 MR. CHAD HARTLE
 2201 WALTON, SUITE A
 JACKSON, MO 63755
 PHONE: (573)-243-1463

ARCHITECT

#9 DESIGN, LLC.
 135 SOUTH PALMER DRIVE STE 200
 ELMHURST, ILLINOIS 60126
 PHONE: (630)-279-9990

SUMMARY TABLE

AREA - TOTAL	304,285 SF
LOT 2	243,399 SF
LOT 3	33,413 SF
LOT 2 & 3 COMBINED	276,812 SF
ROW	27,473 SF
MAX. GROSS FLOOR AREA ALLOWED PER ORDINANCE	
LOT 2 & 3	
PROPOSED GROSS FLOOR AREA	
LOT 2 & 3	68,718 SF
% BUILDING COVERAGE ON LOT	
LOT 2 & 3	24.8%
EXISTING ZONING	B-1(P)
PROPOSED ZONING	MR-2(P)
	LOT 2 & 3
OFF-STREET PARKING REQUIRED (2/DWELLING UNIT)	144
OFF-STREET PARKING PROVIDED	154/8
MAX. BUILDING HEIGHT ALLOWED	35 FT
PROPOSED BUILDING HEIGHT	20 FT
SITE COVERAGE	
BUILDINGS	68,718 SF
PARKING	68,269 SF
SIDEWALK	26,179 SF
OPEN SPACE	113,646 SF
SCHEDULE	
START: NOVEMBER, 2016	
COMPLETE: JANUARY, 2018	



LOCATION MAP
 N.T.S.

PART OF THE N.E. 1/4 OF SECTION 32
 T. 2 N., R. 7 W. OF THE 3RD P.M.

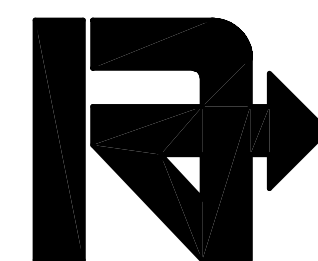

RHUTASEL and ASSOCIATES, INC.

CONSULTING ENGINEERS • LAND SURVEYORS

CORPORATE OFFICE
 4 INDUSTRIAL DRIVE, PO BOX 97
 FREEBURG, ILLINOIS 62243
 (618) 539-3178

IL. LICENSE NO. 184-000287

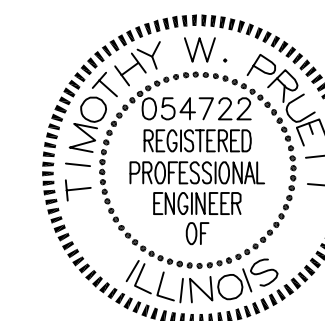

Timothy W. Pruett

Date of Signing

Date of License Expiration

CITY COUNCIL APPROVAL:

THE PRELIMINARY SITE PLAN FOR THE LINCOLN PARK VILLAS WAS APPROVED BY THE CITY COUNCIL OF THE CITY OF O'FALLON, ILLINOIS, ON THE _____ DAY OF _____, 2016.

MAYOR _____ DATE _____

Attest:

CITY CLERK _____ DATE _____

UTILITIES

WATER AND SEWER
 CITY OF O'FALLON
 255 SOUTH LINCOLN AVE
 O'FALLON, ILLINOIS 62269
 618-624-4500

TELEPHONE

AT&T
 203 GOETHE
 COLLINSVILLE, IL 62234
 618-346-7292

ELECTRIC AND GAS

AMEREN IP
 1050 WQUEST BLVD.
 BELLEVILLE, ILLINOIS 62221
 800-755-5000

CABLE

CHARTER COMMUNICATIONS
 317 WEST MAIN ST.
 BELLEVILLE, IL 62220
 888-438-2427

O'FALLON GOVERNMENT CENTER
LOT 2
(PUBLIC LIBRARY)

PLAT BOOK 90, PAGE 26
LOT 1
(POST OFFICE)

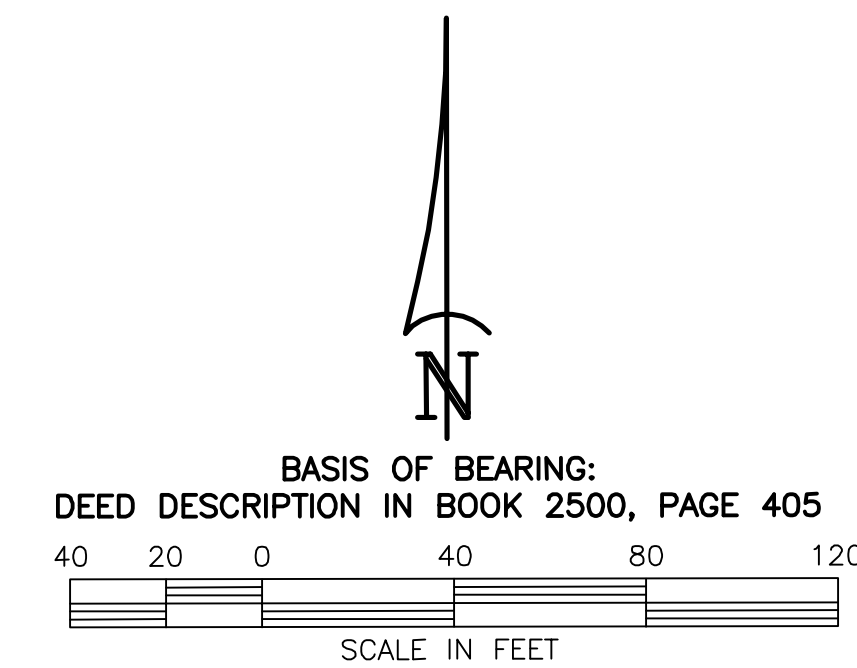

BASIS OF BEARING:
DEED DESCRIPTION IN BOOK 2500, PAGE 405

ALL UTILITY EASEMENTS ARE TO BE USED FOR THE PURPOSES
OF INSTALLATION AND MAINTENANCE OF PUBLIC AND MUNICIPAL
UTILITIES AND FOR SURFACE WATER DRAINAGE.

LEGEND

- ⊗ BRASS PLUG FOUND
- IRON PIN FOUND
- CONCRETE MONUMENT FOUND
- - - EXISTING EASEMENT LINE
- - - PROPOSED EASEMENT LINE
- - - 25' BUILDING SETBACK LINE
- - - PROPOSED ROW
- ⑫ TYPICAL 911 STREET ADDRESS
- ⑭ PARKING COUNT SYMBOL
- ♻️ ACCESSIBLE PARKING

THIRD ADDITION TO SOUTHWIEW GARDENS
PLAT BOOK 56, PAGE 42

SOUTHWIEW GARDENS PLAT BOOK 56, PAGE 12

SOUTH LINCOLN AVENUE (COUNTY HIGHWAY 43)

WESTMINSTER DRIVE 50' R.O.W.

LINCOLN PARK - PLAT BOOK 87, PAGE 57

PRELIMINARY DEVELOPMENT PLAN SITE PLAN			
LINCOLN PARK VILLAS O'FALLON, ILLINOIS			
RHUTASEL and ASSOCIATES, INC. CONSULTING ENGINEERS • LAND SURVEYORS FREEBURG, IL 62243 CENTRALIA, IL 62801 TEL: (618) 539-3178 TEL: (618) 532-1992 E-MAIL: RAS@RHUTASEL.COM ILS-153652-0001			
REVISIONS			
NO.	DATE	DESCRIPTION	BY

DR. BY: M.A.L. APV'D BY: S.W.L. SCALE: AS NOTED SHEET NO. 2
CK'D BY: T.W.P. DATE: MARCH 14, 2016 OF 4

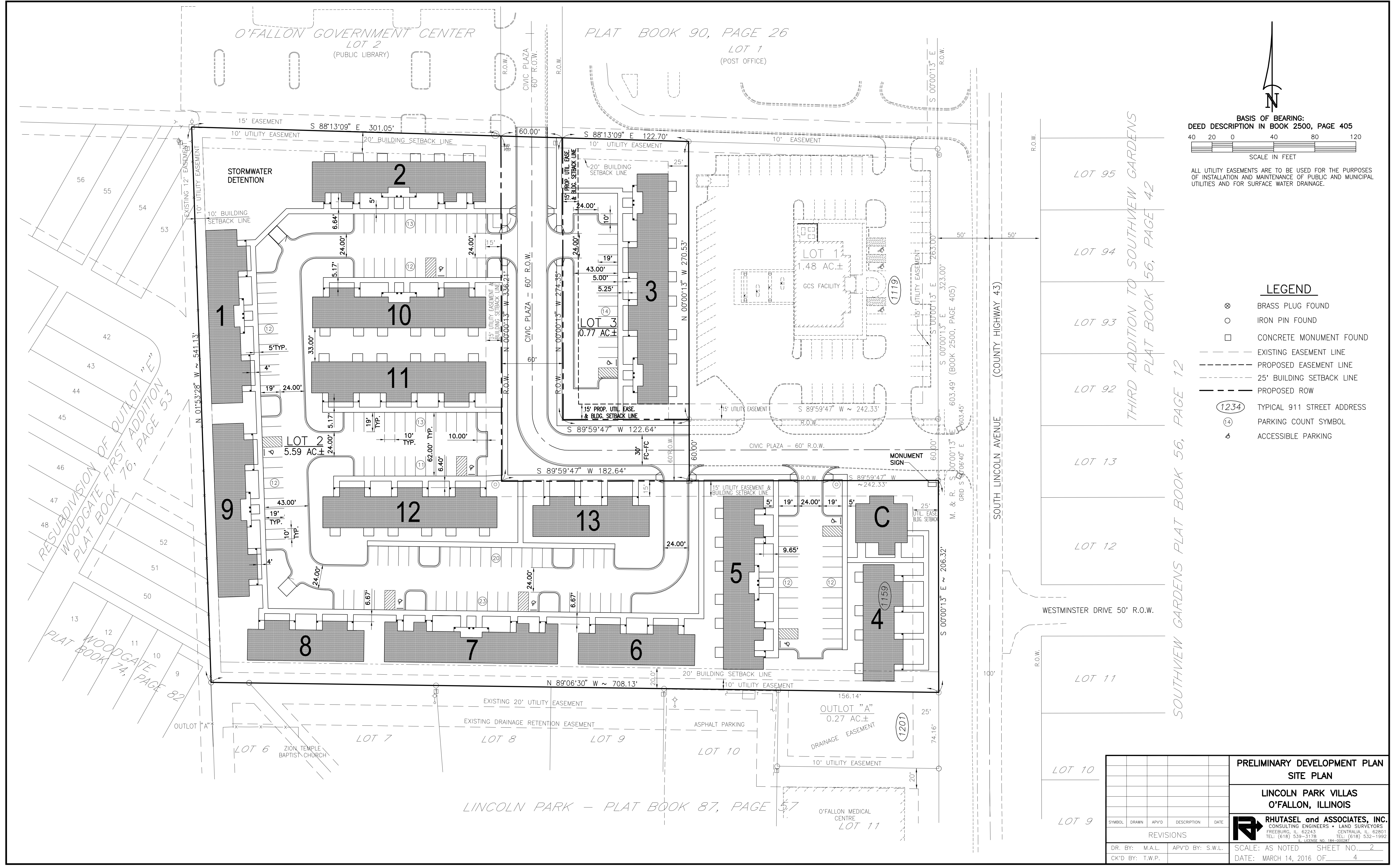

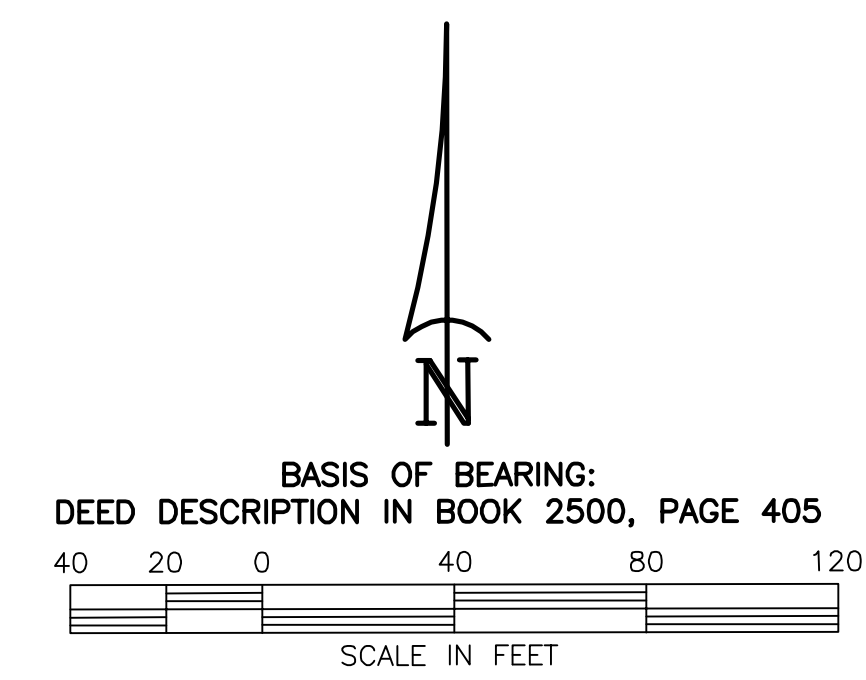
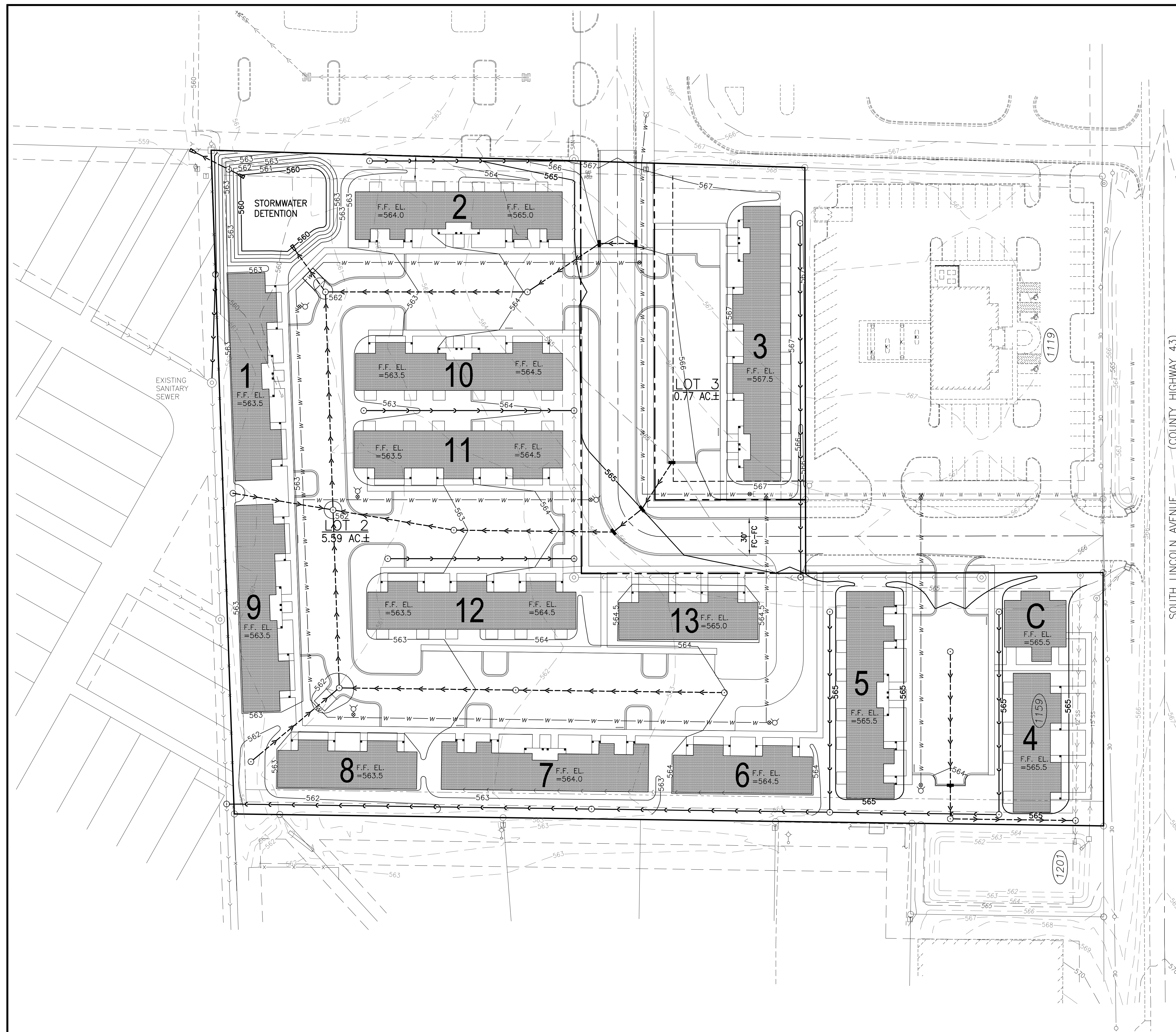

ALL UTILITY EASEMENTS ARE TO BE USED FOR THE PURPOSES OF INSTALLATION AND MAINTENANCE OF PUBLIC AND MUNICIPAL UTILITIES AND FOR SURFACE WATER DRAINAGE.

LEGEND

- ⊗ BRASS PLUG FOUND
- IRON PIN FOUND
- CONCRETE MONUMENT FOUND
- - - - - EXISTING EASEMENT LINE
- - - - - PROPOSED EASEMENT LINE
- - - - - 25' BUILDING SETBACK LINE
- - - - - PROPOSED ROW
- (1234) TYPICAL 911 STREET ADDRESS
- ⊙ EXISTING SANITARY MANHOLE
- ⊕ PROPOSED FIRE HYDRANT
- PROPOSED WATER VALVE
- PROPOSED STORM MANHOLE
- PROPOSED STORM CURB INLET
- PROPOSED SANITARY MANHOLE
- w-w- PROPOSED WATER MAIN
- s-s- PROPOSED STORM SEWER
- >>- PROPOSED SANITARY SEWER

REVISIONS			
NO.	DATE	DESCRIPTION	BY

DR. BY: M.A.L.	APV'D BY: S.W.L.	SCALE: AS NOTED	SHEET NO. 3
CK'D BY: T.W.P.		DATE: MARCH 10, 2016	OF 4

**PRELIMINARY DEVELOPMENT PLAN
UTILITY AND GRADING PLAN**

**LINCOLN PARK VILLAS
O'FALLON, ILLINOIS**

RHUTASEL and ASSOCIATES, INC.
CONSULTING ENGINEERS • LAND SURVEYORS
FREEBURG, IL 62243 CENTRALIA, IL 62801
TEL: (618) 539-3178 TEL: (618) 532-1992
E-MAIL: RHA@RHA-IL.COM 184-00002

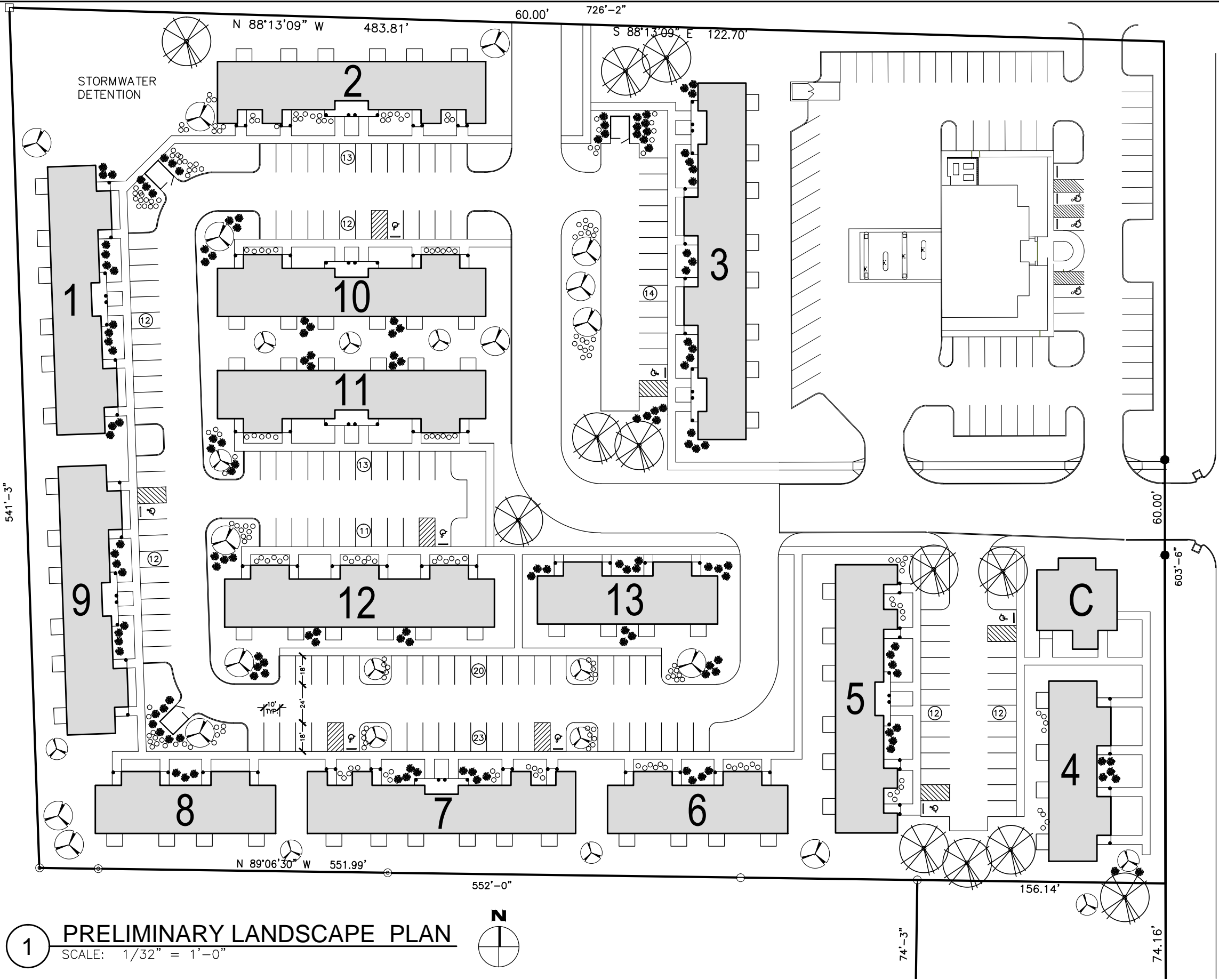

LANDSCAPE LEGEND	
	8 - RED MAPLE (ACER RUBRUM L.)
	14 - EASTERN REDBUD (CERCIS CANADENSIS)
	3 - NORTHERN WHITE CEDAR (THUJA OCCIDENTALIS)
	23 - COMMON LILAC (SYRINGA VULGARIS)
	38 - CHINESE JUNIPER (JUNIPERUS CHINENSIS)

1 PRELIMINARY LANDSCAPE PLAN
 SCALE: 1/32" = 1'-0"



S. LINCOLN AVE

RCH DEVELOPMENT, INC.
 2201 WALTON DRIVE, SUITE A
 JACKSON, MO 63755

LINCOLN PARK SENIOR VILLAS
 1159 SOUTH LINCOLN AVENUE
 O'FALLON, ILLINOIS 62269

#9 Design, LLC
 135 S. Palmer Drive, Suite 200
 Elmhurst, IL 60126

DATE
2/29/2016

A0.2

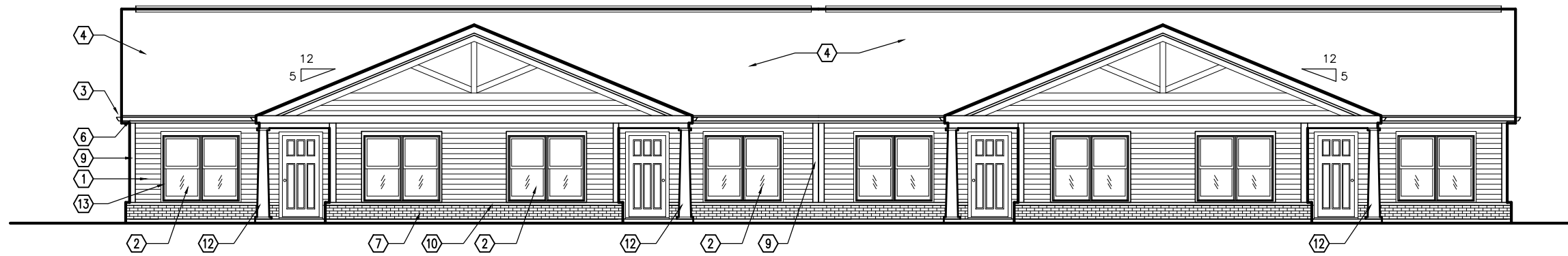

ELEVATION KEYNOTES	
①	PREFINISHED FIBER CEMENT LAP SIDING WITH 4" PROFILE
②	PREMIUM VINYL LOW E INSULATED GLASS WINDOW
③	PREFINISHED SEAMLESS GUTTER
④	ENERGY STAR RATED ASPHALT SHINGLES
⑤	STONE VENEER
⑥	ALUMINUM FASCIA AND SOFFIT
⑦	4" THICK BRICK VENEER
⑧	PREFINISHED SEAMLESS DOWNSPOUT
⑨	1 x 6 PREFIN. FIBER CEMENT TRIM BOARDS
⑩	PRECAST CONCRETE STONE CAP
⑪	DECORATIVE BRACKET
⑫	LOAD BEARING FIBERGLASS COLUMN
⑬	VINYL SHUTTER
⑭	PREFINISHED FIBER CEMENT BOARD & BATTEN SIDING
⑮	PREFINISHED FIBER CEMENT SHINGLE SIDING

1 EXTERIOR FRONT ELEVATION - 4 UNIT BUILDING
 SCALE: 3/32" = 1'-0" BUILDINGS 4, 6, 8 AND 13

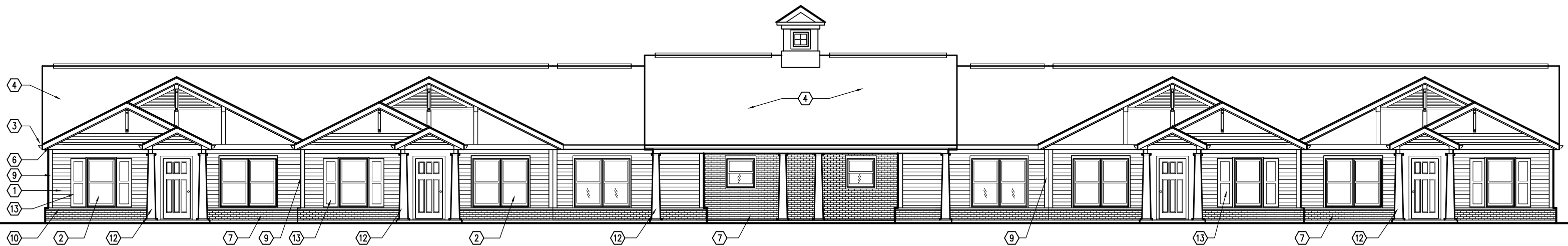

2 EXTERIOR FRONT ELEVATION - 6 UNIT BUILDING - TYPE A
 SCALE: 3/32" = 1'-0" BUILDINGS 2, 5 AND 7

RCH DEVELOPMENT, INC.
 2201 WALTON DRIVE, SUITE A
 JACKSON, MO 63755

LINCOLN PARK SENIOR VILLAS
 1159 SOUTH LINCOLN AVENUE
 O'FALLON, ILLINOIS 62269

#9 Design, LLC
 135 S. Palmer Drive, Suite 200
 Elmhurst, IL 60126

DATE
 2/29/2016

A2.0

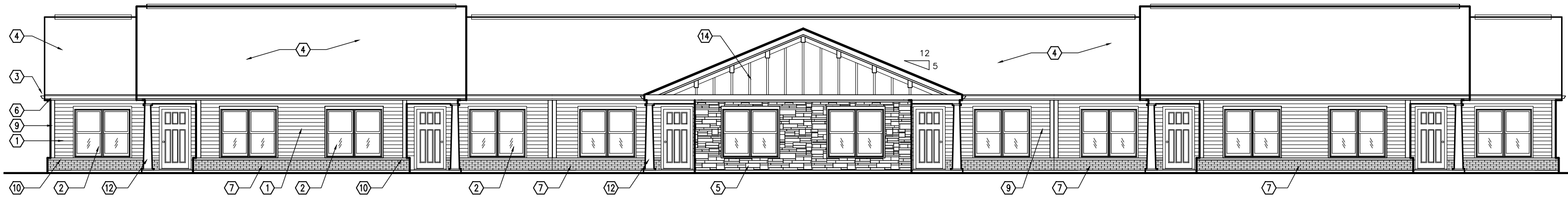

1 EXTERIOR FRONT ELEVATION - 6 UNIT BUILDING - TYPE B
 SCALE: 3/32" = 1'-0" BUILDINGS 11 AND 12

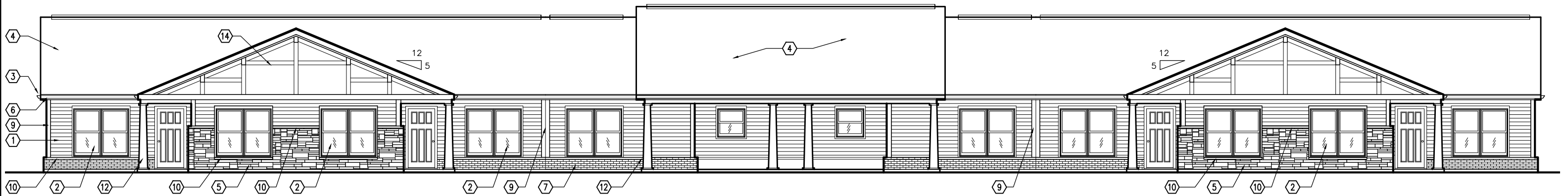

2 EXTERIOR FRONT ELEVATION - 6 UNIT BUILDING - TYPE C
 SCALE: 3/32" = 1'-0" BUILDINGS 1, 9 AND 10

RCH DEVELOPMENT, INC.
 2201 WALTON DRIVE, SUITE A
 JACKSON, MO 63755

LINCOLN PARK SENIOR VILLAS
 1159 SOUTH LINCOLN AVENUE
 O'FALLON, ILLINOIS 62269

#9 Design, LLC
 135 S. Palmer Drive, Suite 200
 Elmhurst, IL 60126

DATE
 2/29/2016

A2.1

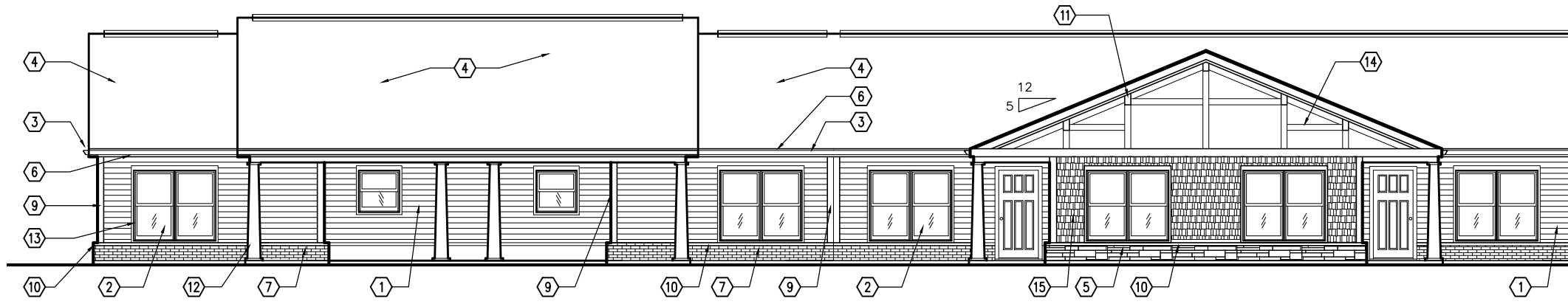

1 EXTERIOR FRONT ELEVATION - 8 UNIT BUILDING - PARTIAL
 SCALE: 3/32" = 1'-0" BUILDING 3

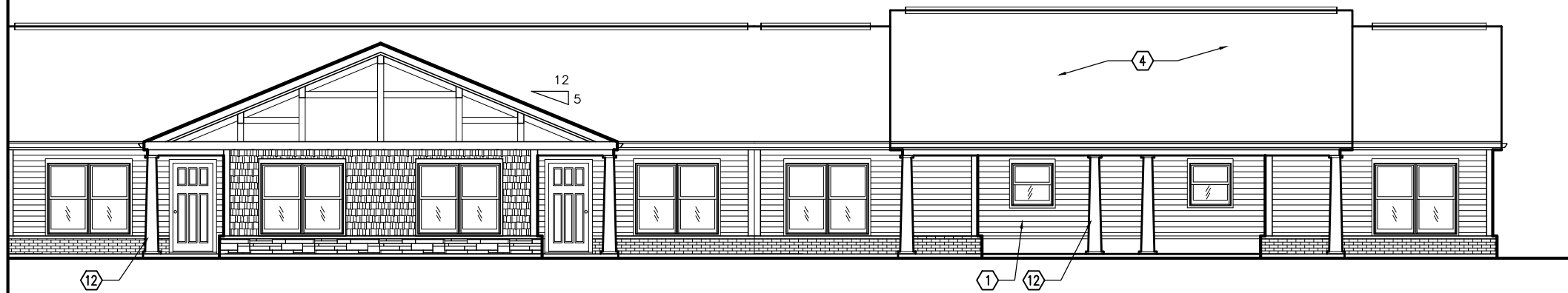

2 EXTERIOR FRONT ELEVATION - 8 UNIT BUILDING - PARTIAL
 SCALE: 3/32" = 1'-0" BUILDING 3



3 EXTERIOR FRONT ELEVATION - COMMUNITY BUILDING
 SCALE: 3/32" = 1'-0"

RCH DEVELOPMENT, INC.
 2201 WALTON DRIVE, SUITE A
 JACKSON, MO 63755

LINCOLN PARK SENIOR VILLAS
 1159 SOUTH LINCOLN AVENUE
 O'FALLON, ILLINOIS 62269

#9 Design, LLC
 135 S. Palmer Drive, Suite 200
 Elmhurst, IL 60126

DATE
 2/29/2016

A2.2



LINCOLN PARK SENIOR VILLAS
O'Fallon, Illinois

May 16, 2016



#9 Design, LLC.

RCH DEVELOPMENT, INC.
2201 Walton Drive, Suite A
Jackson, MO. 63755

ORDINANCE NO. _____

**AN ORDINANCE AMENDING
ORDINANCE 623, ZONING DISTRICTS
OF THE CITY OF O’FALLON, ILLINOIS
(DEVELOPMENT KNOWN AS “LINCOLN
PARK VILLAS”) LOCATED AT 1159
LINCOLN AVENUE, PARCEL NUMBER
04-31.0-216-037**

WHEREAS, the applicant, Chad Hartle of RCH Development, Inc., has filed an application requesting approval of a planned use rezoning to authorize construction of a 72-unit senior living community at 1159 Lincoln Avenue in O’Fallon; and

WHEREAS, the applicant has filed an application with the City of O’Fallon, Illinois pursuant to the requirements of all applicable laws, including City Ordinance 3471, “Planned Uses”; and

WHEREAS, the Planning Commission of the City of O’Fallon, Illinois held a public hearing on May 23, 2016, in accordance with state statute, and recommended to approve the petitioner’s request to obtain a MR-2(P) Planned Multi-Family Residential Dwelling District zoning for the property with a vote of 5 ayes to 1 nays as outlined in the adopted Planning Commission Report, attached hereto and declared to be an inseparable part hereof (Exhibit A); and

WHEREAS, on June 13, 2016 the Community Development Committee of the City Council reviewed the rezoning and recommended approval with a vote of X ayes to X nays.

**NOW, THEREFORE, BE IT ORDAINED BY THE MAYOR AND CITY
COUNCIL OF THE CITY OF O’FALLON, ST. CLAIR COUNTY, ILLINOIS AS
FOLLOWS:**

Section 1. That upon the effective date of this Ordinance, the described property, known as “Lincoln Park Villas”, be henceforth classified as zoning district MR-2(P) Planned Multi-Family Residential Dwelling District with the following conditions:

1. There will be a park land dedication requirement of 0.72 acre, with the requirement being fulfilled through a fee in lieu of land in the amount of \$36,720, \$510.00 per unit.
2. A revised landscaping plan is required to including street trees and fencing.
3. A final plat is required with a note restricting the limit the age of the renters to 55 or older
4. A final plat is required with a note restricting the sale of individual lots and buildings.
5. The lots along the Woodgate subdivision are required to be setback 20 feet from the property line.

Section 2. A Certified Copy of this ordinance, with all referenced attachments, shall be filed with the City Clerk’s office of the City of O’Fallon, Illinois.

Upon its passage and approval, this Ordinance shall be in full force and effect ten (10) days after its publication in pamphlet form as required by law.

Upon its passage and approval, this Ordinance shall be in full force and effect ten (10) days after its publication in pamphlet form as required by law.

Passed by the City Council this _____ day of _____ 2016.

ATTEST:

(seal)

Approved by the Mayor this _____ day
of _____ 2016.

Philip A. Goodwin, City Clerk

Gary L. Graham, Mayor

ROLL CALL:	McCoskey	Meile	Kueker	Albrecht	Hagarty	Drolet	SUB TOTALS
Aye							
Nay							
Absent							

ROLL CALL:	Roach	Bennett	Marsh	Smallheer	Holden	Cozad	Gerrish	SUB TOTALS	SUM OF TOTALS
Aye									
Nay									
Absent									



M E M O R A N D U M

TO: Community Development Committee
FROM: Justin Randall, Senior City Planner
THRU: Ted Shekell, Community Development Director
DATE: June 13, 2016
SUBJECT: P2016-04: Proposed Text Amendment – Permitted Principal Structures in the SR-3 Zone District (1st Reading)

Current Issue

City staff is proposing a text amendment to prohibit new modular homes in the SR-3 Single Family Residence Dwelling District, which will not affect existing modular homes currently in an SR-3 zone district. There has not been a problem with the regulations as currently drafted until recently, a modular home was placed on a lot in an SR-3, Single-Family Residence Dwelling District that is inconsistent with the stick built homes surrounding the modular home. The home is not oriented towards the street and appears to look like a manufactured home. Modular and manufactured homes are homes that are constructed in a factory and brought to the site as a whole home or in large modules and are regulated by the State of Illinois. The City's Code differentiates between modular homes (placed on a permanent foundation) and manufactured homes (able to be relocated easily), however the City's regulations do not regulate orientation or style of the modular homes. The home was approved by city staff as it met all current codes, however, this new structure has spurred discussion on how to regulate the vast differences between the design characteristics of modular homes.

Proposal

There are two potential options to regulate modular homes in the SR-3 zone districts; prohibit modular homes or require a special use permit. Staff has evaluated surrounding communities and each takes a different approach, between what residential districts they are permitted and whether a special use is required. Staff also researched modular home options that could be purchased. There is a vast difference in the design characteristics offered by different modular home manufactures, from the basic double-wide home with very little character and minimum roof pitch to a very ornate two-story home. Due to the wide variety of options available, staff believes it would be very difficult to regulate the aesthetics and design of the home. Therefore, the proposed text amendment would prohibit a modular home in the SR-3 zone district. Modular homes would still be allowed in the MR-1, MR-2, MH-1 and MH-2 zone districts. This will cause some non-conforming structures throughout the city, but will not affect existing modular home and only prohibit any new ones to be place in the SR3 zone district. The following are the proposed changes to the City's Code of Ordinances:

- §158.037 (6) SR-3, Single-Family Residence Dwelling District.
 - (a) *Permitted principal structures.* Building structures of the following classes: Class 1, conventionally-built building structures; and Class 2, prefabricated building structures; ~~and Class 3, modular building structures.~~

Recommendation

Staff recommends adopting the text amendment to prohibit a modular building structure in the SR-3 zone district.

Community Development Department
255 South Lincoln Avenue • O'Fallon, IL • 62269 ♦ P: 618.624.4500 x 4 ♦ F:618.624.4534